



**ECOSCAPE**[®] UK
COMPOSITE DECKING, FENCING & CLADDING

ENVIRONMENTAL SUSTAINABILITY

All of our composite decking, cladding and fencing materials are made using a mixture of reclaimed timber fibres, recycled HDPE and environmentally sustainable bonding agents and dyes to create high quality products that replicate the characteristics of timber without any of the drawbacks; like rotting, warping, drastic colour fading, ongoing maintenance etc.

The use of recycled HDPE plastics helps aid in the battle to reduce landfill and ocean plastics but also reducing our carbon footprint.



Look for our FSC® certified products throughout the brochure.

The mark of responsible forestry
FSC® C181157



4	CLARITY COMPOSITE DECKING	66	NEW FORMA COMPOSITE CLADDING FOR GRAD
10	FORMA COMPOSITE DECKING	78	NEW FORMA COMPOSITE GARDEN SHEDS
20	LINEA COMPOSITE DECKING	82	CLARITY COMPOSITE FENCING & GATES
26	GRANDE COMPOSITE DECKING	90	NEW EASY FIT ALUMINIUM DECKING
32	CRADLE & PEDESTAL SYSTEMS	98	NEW NON-COMBUSTIBLE PEDESTALS
42	TIMBER FREE SUBSTRUCTURES	104	BALUSTRADE SYSTEMS
44	FORMA COMPOSITE PANEL CLADDING	110	OUTDOOR KITCHENS
52	FORMA COMPOSITE SLATTED CLADDING	114	BIN STORAGE
62	NEW FORMA PRO COMPOSITE CLADDING TRIMS		



INNOVATIVE & SUSTAINABLE DESIGN

As manufacturers of wood plastic composite products, our collection includes attractive low maintenance decking, cladding, fencing and balustrade systems.

We aim to be at the forefront of the garden design industry with excellent quality, stylish and efficient systems that not only look beautiful but perform to the highest standard.

We use recycled plastic in all of our composite products. In 2025 alone we recycled 4,401 tonnes of waste plastic in our materials.

MIDNIGHT
Forma Composite
Slatted Cladding

CLARITY® COMPOSITE DECKING



WALNUT
Clarity Composite
Decking

Ecoscope Clarity® composite decking is a long lasting, low maintenance alternative to timber decking. Made up of recycled high density polyethylene plastic and reclaimed wood fibres. This unique makeup draws on the durability of synthetic products whilst maintaining the natural look and malleability of timber without any of its notable drawbacks.

This attractive and sustainable composite decking board is available in 3 beautiful colours and has a dual surface finish meaning the board can be laid either side up to achieve a different aesthetic.

Our Clarity® boards have also been independently tested to BS 7976-2:2002 and are slip resistant in both wet and dry conditions, making family safety one of its most attractive selling points.



GRAPHITE
Clarity Composite
Decking

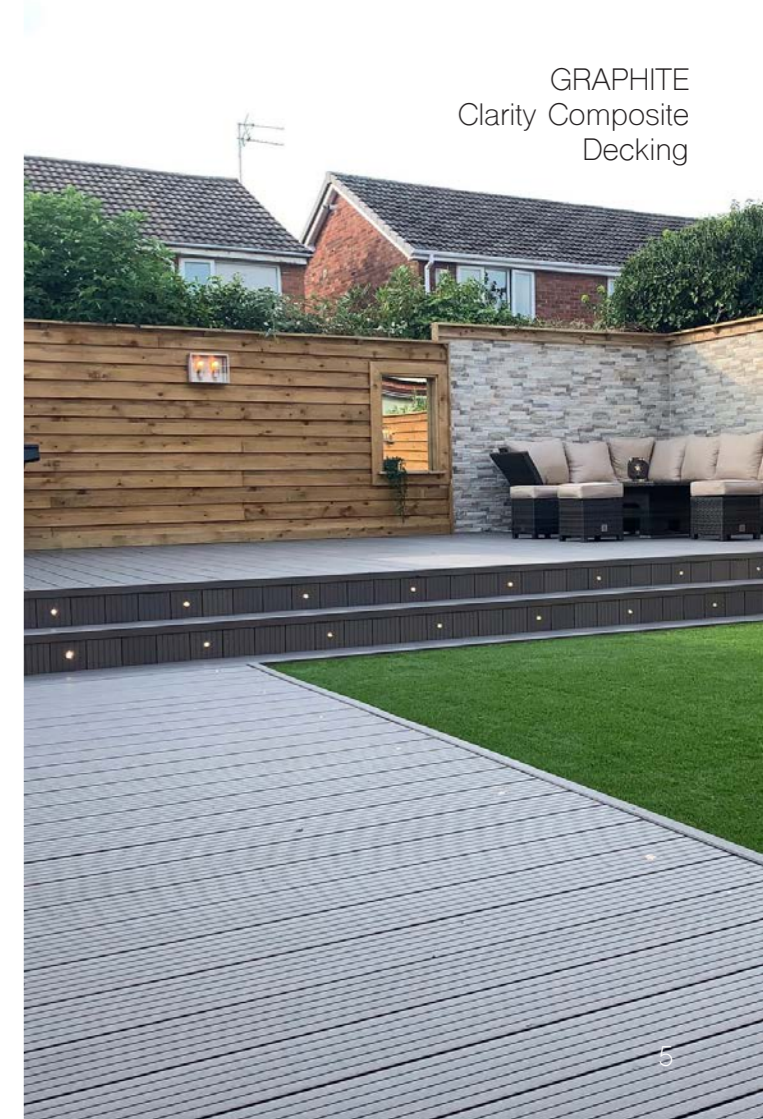

Clarity® boards are dual sided with wide grooves on one side and narrower grooves on the other.



Our T-Clip fixing system is engineered for quick and easy installation whilst maintaining a high quality finish. The clips space decking boards evenly allowing for expansion and contraction with temperature fluctuation.

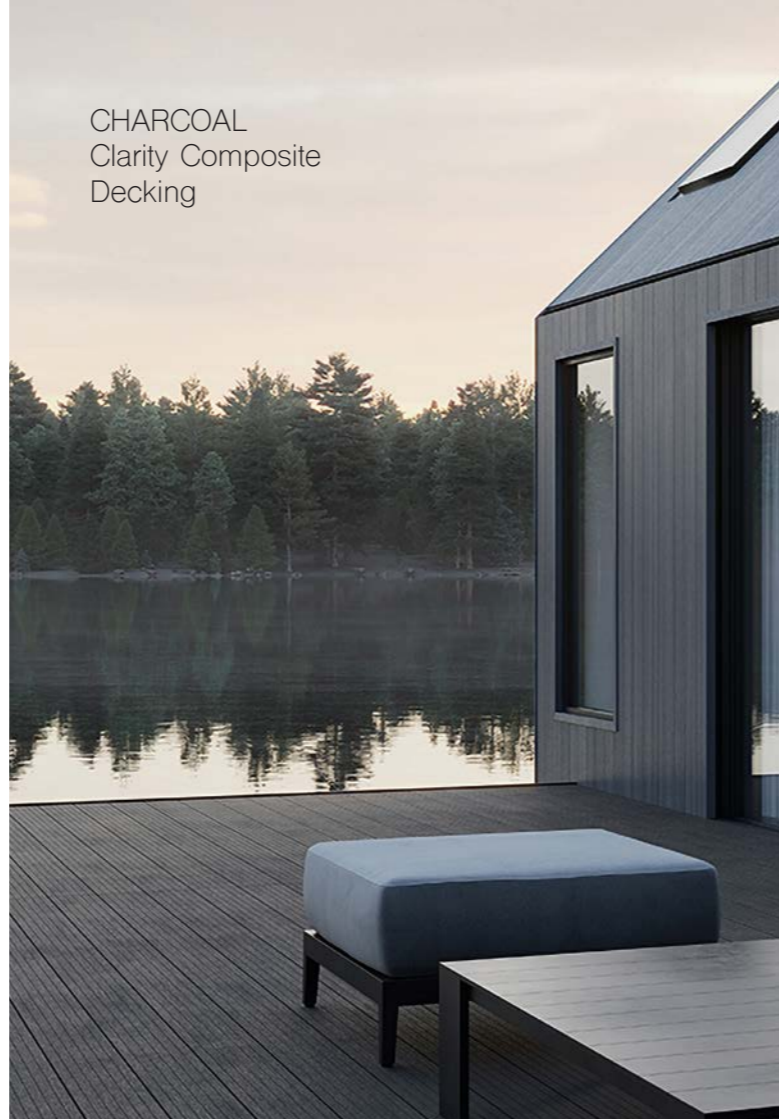

CHARCOAL
Clarity Composite
Decking

CLARITY® COMPOSITE DECKING

Walnut

25mm x 150mm x 3000mm/4800mm



Graphite

25mm x 150mm x 3000mm/4800mm

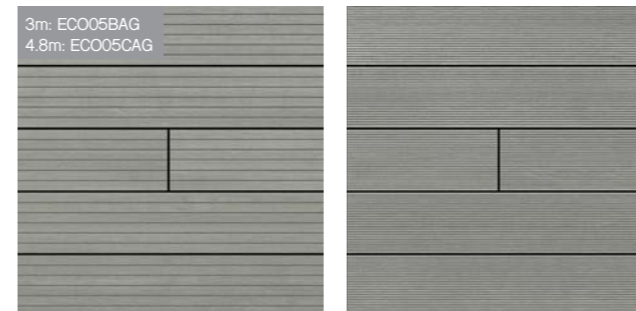

Request free samples at www.ecoscape.co.uk

Dual surface boards, wide groove on one side, narrow groove on the other.



Charcoal

25mm x 150mm x 3000mm/4800mm

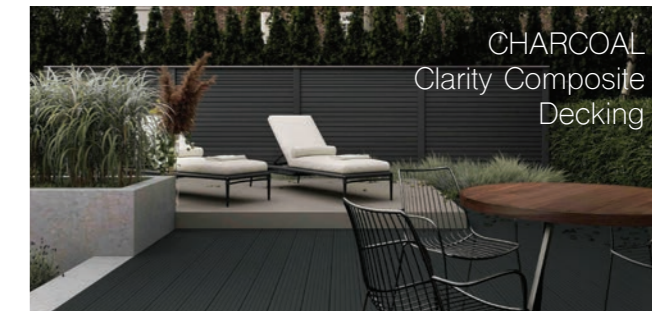
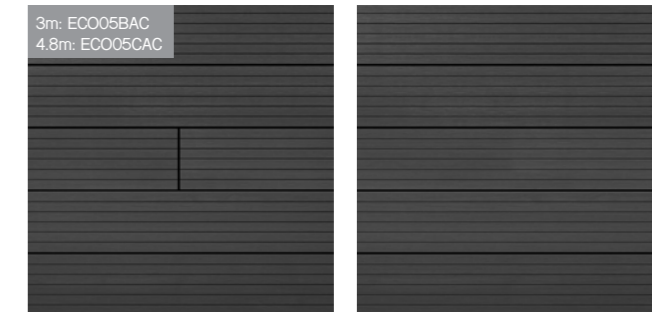

CLARITY® COMPOSITE DECKING ACCESSORIES

Angle Trim

42mm x 42mm x 3000mm

ECO06AX3



6mm trim thickness

Flat Fascia Trim

15mm x 150mm x 3000mm

ECO15015X

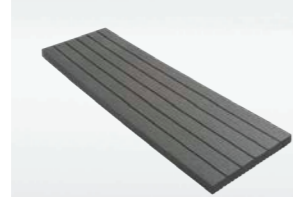

Dual sided

Colour Coded Screws

63mm

Pack of 50: ECO09CS50XX63



NOTE: Lighter Clarity boards will show greater colour settling due to smaller quantities of dye and greater UV exposure to the natural wood fibres. After 3 months of UV exposure colour remains consistent.

Hidden T- Clip Fixings

250pcs, incl screws & 1 drill bit

ECO09CS



Locking Clip Fixings

50pcs, incl screws

ECO09LC



Start/Finish Clips

50pcs

ECO09SF



BENEFITS OF CLARITY® DECKING

- Environmentally conscious design using ethically sourced materials
- 95% recycled content
- FSC® certified
- Slip resistant surface
- Low maintenance – no need to paint, stain or seal
- Does not rot, warp or splinter
- Natural looking without many of the drawbacks of timber
- Easy installation system with invisible fixings
- 20 year warranty



FLINT
Forma
Composite
Decking





FLINT
Forma
Composite
Decking

Forma composite decking is our premium composite with a durable polymer outer shell encapsulating the board. This capping forms an impermeable layer that protects from scratching, staining and fading making it the ultimate carefree, low maintenance flooring.

Available in six beautiful colours this stylish and sustainable decking board can instantly elevate any project into a luxury space.

The T-Clip fixing system allows boards to move freely with expansion and contraction preventing any buckling, twisting or warping. This clip is also conveniently hidden in the grooves of the decking board so there are no visible fixings through the top of the decking.



Our Locking Clip is similar to the T-Clip but with serrated teeth which locks the board in place. This ensures even expansion or contraction during hot or cold weather but prevents the board from sliding.



ARGENT
Forma
Composite
Decking

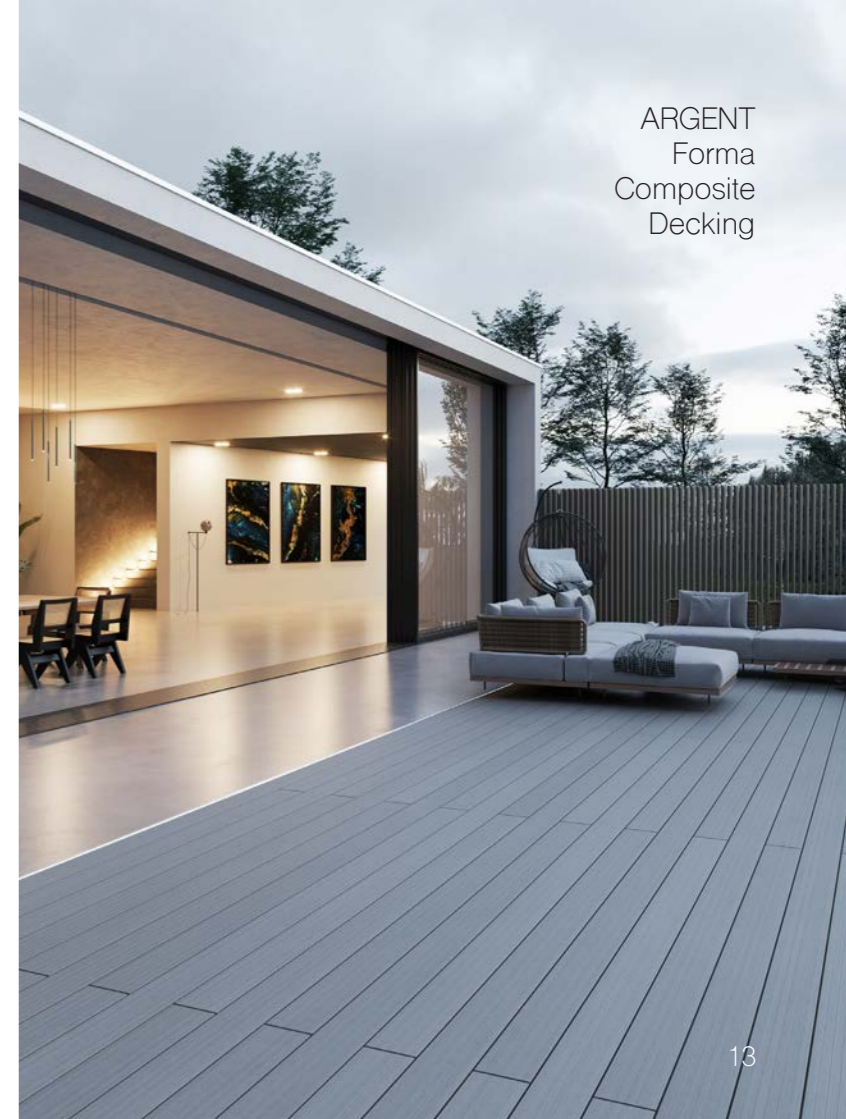



SPICED OAK
Forma Composite Decking

Forma's 360° co-extrusion durable capping is not only scratch and stain resistant, it also beautifully replicates the natural grain, dual tone and texture of timber.



With a 25 year warranty and UV bleaching resistant technology Forma decking requires minimal maintenance to keep its vibrant colour.

FORMA® COMPOSITE DECKING



Dual surface boards, wide groove on one side, woodgrain on the other.

Havana

25mm x 150mm x 3000mm
25mm x 150mm x 4800mm



Silver Birch

25mm x 150mm x 3000mm
25mm x 150mm x 4800mm



Flint

25mm x 150mm x 3000mm
25mm x 150mm x 4800mm



Argent

25mm x 150mm x 3000mm
25mm x 150mm x 4800mm



Spiced Oak

25mm x 150mm x 3000mm
25mm x 150mm x 4800mm

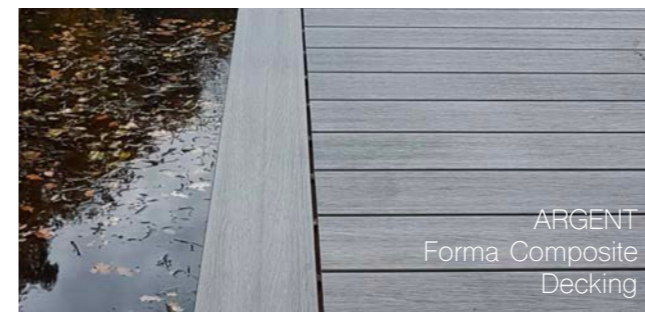
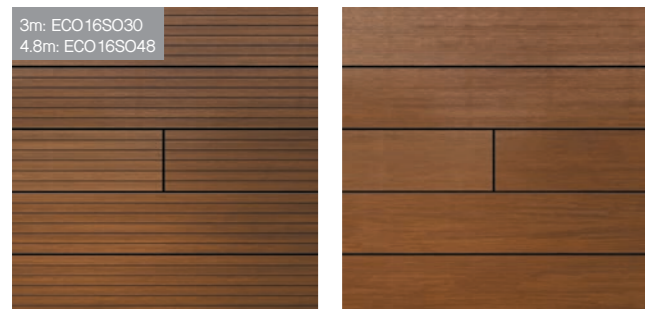

Midnight

25mm x 150mm x 3000mm
25mm x 150mm x 4800mm



FORMA® COMPOSITE DECKING ACCESSORIES

Angle Trim

40mm x 40mm x 3000mm

ECO18XX3



8mm trim thickness

Flat Fascia Trim

10mm x 150mm x 3000mm

ECO17XX3



Dual sided

Solid Edge Board

25mm x 150mm x 3000mm

ECO19XX



Dual sided

Hidden Screws & Composite Plugs

Screw: ECO09HS
Plug: ECOCPXX

NEW



Breaker Board Locking Clip

ECODBLKGCL

NEW



Hidden T- Clip Fixings

250pcs, incl screws* & 1 drill bit

ECO09CS



Locking Clip Fixings

50pcs, incl screws*

ECO09LC



Start/Finish Clips

50pcs

ECO09SF



Colour Coded Screws

63mm

Pack of 50: ECO09CS50XX63



Breaker Board Clip

ECODBBCL

NEW



* Available with wood or aluminium screws

BENEFITS OF FORMA® DECKING

- Environmentally conscious design using ethically sourced materials
- 95% recycled content
- FSC® certified
- Durable capping for UV and stain resistance
- Low maintenance – no need to paint, stain or seal
- Does not rot, warp or splinter
- Natural looking without many of the drawbacks of timber
- Easy installation system with invisible fixings
- 25 year warranty

LINEA COMPOSITE DECKING



GRANITE
Linea Composite
Decking

The latest addition to our decking collection is available in 4 colours and has a capped exterior protecting it from harmful UV rays, scratches and extreme weather. As with our other products, Linea is long lasting, low maintenance and sustainably produced using 95% recycled materials.



SLATE
Linea Composite
Decking

Each Linea deck board has its own distinct character through a unique colour streaking process that imitates natural timber and creates a truly individualised aesthetic.



UMBER
Linea
Composite
Decking

Linea decking offers a capped board with a traditional groove pattern to one side and a modern straight grain to the other for a choice between a classic or a more streamlined aesthetic.



Traditional
Groove Side

Straight
Grain Side

LINEA COMPOSITE DECKING

Dual sided boards, traditional groove on one side, straight grain on the other.

Onyx

23mm x 140mm x 3600mm/4800mm

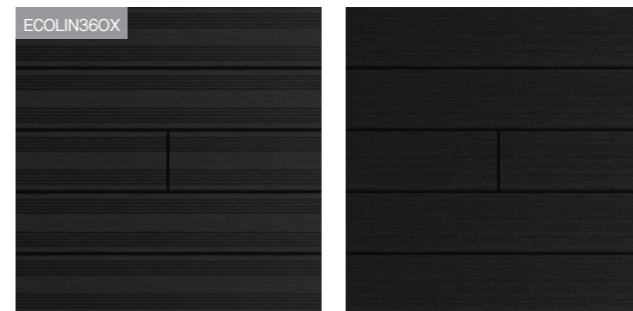

Slate

23mm x 140mm x 3600mm/4800mm



Granite

23mm x 140mm x 3600mm/4800mm



Umber

23mm x 140mm x 3600mm/4800mm



Request free samples at www.ecoscape.co.uk

LINEA COMPOSITE DECKING ACCESSORIES

Angle Trim

40mm x 40mm x 3600mm

ECOLINATXX



8mm trim thickness

Flat Fascia Trim

15mm x 150mm x 3600mm

ECOLINFAXX



Dual sided

Solid Edge Board

23mm x 140mm x 3600mm

ECOLINSOLXX



Dual sided

Hidden Screws & Composite Plugs

Screw: ECO09HS
Plug: ECOCPXX

NEW



Hidden T- Clip Fixings

250pcs, incl screws & 1 drill bit

ECO09CS



Locking Clip Fixings

50pcs, incl screws

ECO09LC



Start/Finish Clips

50pcs

ECO09SF



Colour Coded Screws

63mm

Pack of 50: ECO09CS50XX63



BENEFITS OF LINEA DECKING

- Low price point
- Environmentally conscious design using ethically sourced materials
- 95% recycled content
- FSC® certified
- Durable capping for UV and stain resistance
- Low maintenance – no need to paint, stain or seal
- Does not rot, warp or splinter
- Natural looking without many of the drawbacks of timber
- Easy installation system with invisible fixings

GRANDE COMPOSITE DECKING



Similar to our Forma range, our Grande decking boards are made up of 95% recycled material and uses advanced co-extrusion technology which generates an externally durable outer layer.

As the name suggests, the Grande board is 50% wider than a standard decking board at 225mm – for an elegant and contemporary look – which has the added benefit of being quicker to fit.

CHATEAU
Grande Composite
Decking

DOVETAIL
Grande Composite
Decking

Our capped technology and advanced brushing techniques create a composite decking board with exceptional anti-slip values, is UV stable and comes with a 25 year guarantee.

We offer two dual-sided Grande boards, available in a choice of the rich, dark Noir and Mocha tones (new for 2026) or the lighter Dove-tail and Chateau shades. Each side features a natural-looking woodgrain finish.

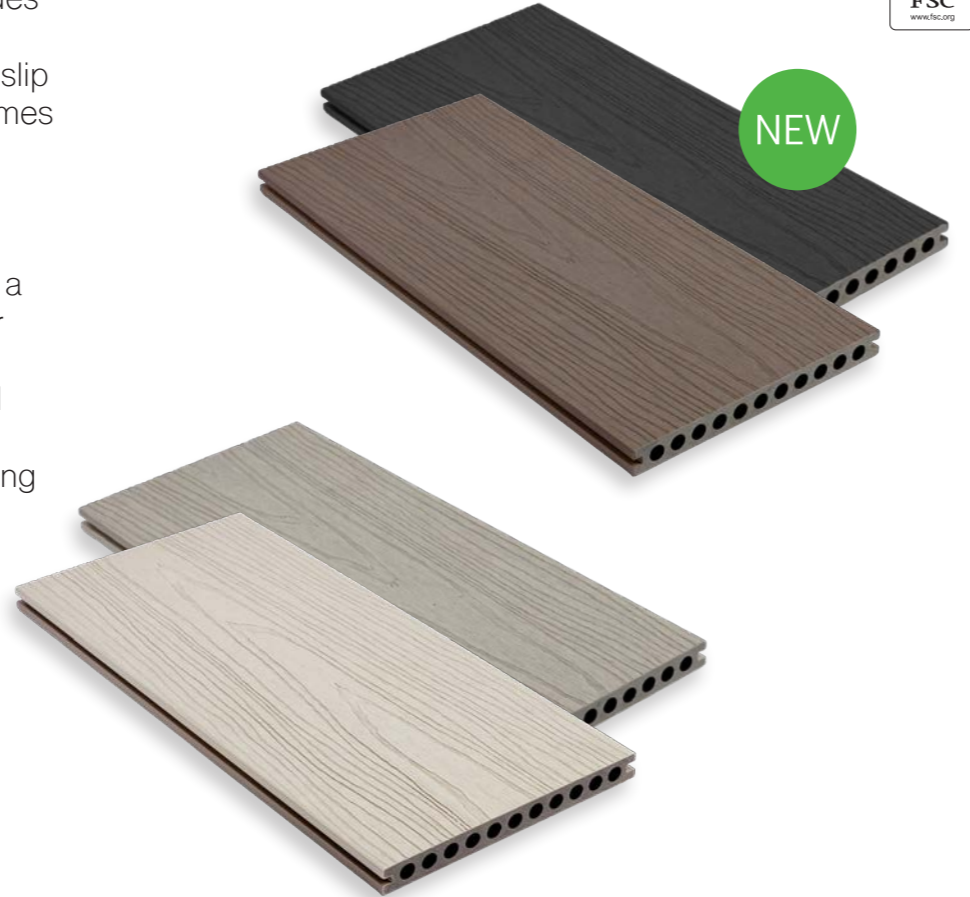

NEW

GRANDE COMPOSITE DECKING

Noir / Mocha

22mm x 225mm x 3600mm

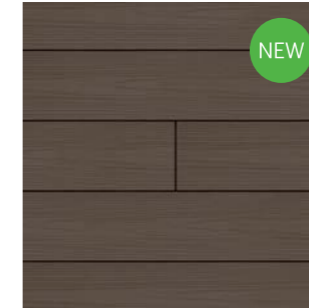
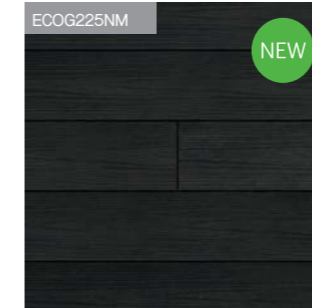

Chateau / Dove-tail

22mm x 225mm x 3600mm



CHATEAU
Grande Composite
Decking

GRANDE COMPOSITE DECKING ACCESSORIES

Angle Trim

50mm x 50mm x 3000mm

ECO50CH/DT



8mm trim thickness

Flat Fascia Trim

15mm x 150mm x 3000mm

ECOG15CH/DT



Solid Edge Board

22mm x 225mm x 3600mm

ECOSOL225CH/DT

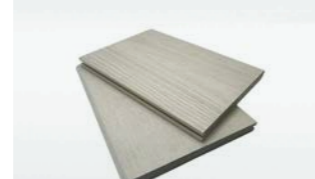

Composite Plugs & Hidden Screws

Screw: ECO09HS
Plug: ECOCPXX



Hidden T- Clip Fixings

250pcs, incl screws & 1 drill bit

ECO09CS



Locking Clip Fixings

50pcs, incl screws

ECO09LC



Start/Finish Clips

50pcs

ECO09SF



Colour Coded Screws

63mm, 50pcs

ECO09CS50XX63



BENEFITS OF GRANDE DECKING

- Environmentally conscious design using ethically sourced materials
- 95% recycled content
- FSC® certified
- Durable capping for UV and stain resistance
- Low maintenance – no need to paint, stain or seal
- Does not rot, warp or splinter
- Natural looking without many of the drawbacks of timber
- Easy installation system with invisible fixings
- 25 year warranty

CRADLE & PEDESTAL SYSTEMS

Queen Pedestals
(see p. 38) & Forte
Plastic Substructure
(see p.42)

All of our cradle and pedestal systems are made in Italy from 100% recycled polypropylene, our pedestals also come with anti-noise rubber coated heads, using advanced electric injection presses which release no emissions or waste oil.

Our five ranges include King, Queen, Junior and Lord pedestals and our new Mito cradles, all beautifully boxed in our 100% FSC® packaging. Our ranges come with a 15 year limited warranty and 40+ year design life. We have 10 European registered patents, with our technology being unique to the market.

Across the five ranges you have the choice of self-levelling base supports, self-levelling heads and fixed supports, complete with a range of tools and ancillaries to cater for most laying issues and needs.

For technical information visit www.ecoscape.co.uk

“The market’s only recycled polypropylene support with a load capacity exceeding 1800kg”



KING
K5 Paving Pedestals



MITO JOIST CRADLE

Our new Mito decking joist cradle is a stable and secure system with stackable extensions, providing a support with adjustable heights from as low as 12mm up to 102mm. Thanks to the adjustment ring the height can be adapted in increments of millimetres, satisfying every height need with the help of only 2 items.

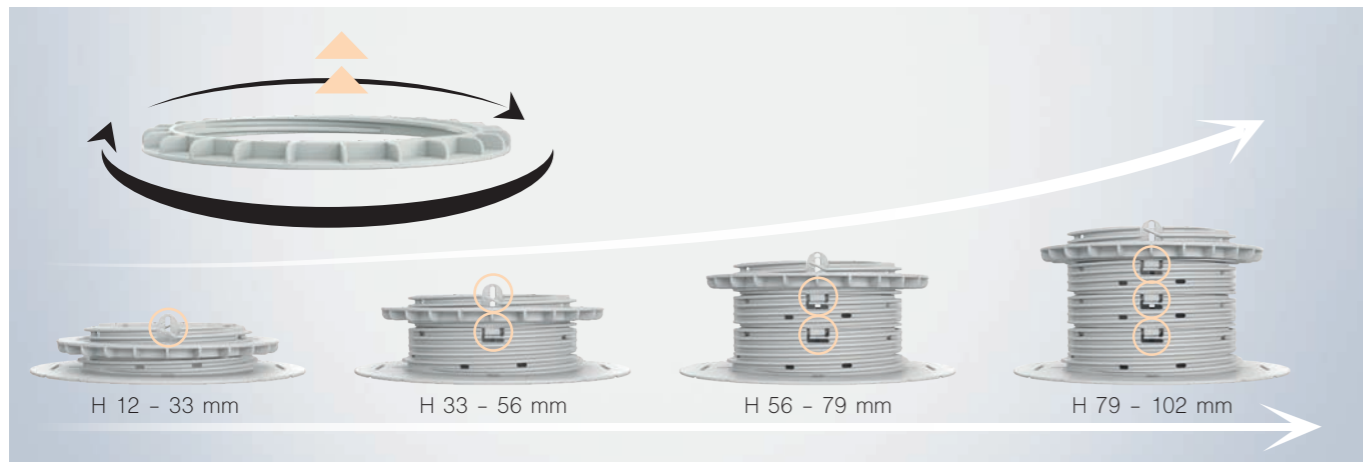

The Mito base and extensions are equipped with a double fixing hook which attaches the extensions with a simple pressure. Mito also features a maximum height safety block, which interrupts the movement of the adjustment ring when it reaches the top, always guaranteeing the loading capacity needed for the flooring.

MITO JOIST CRADLE

Joist Cradle System

12mm - 102mm height

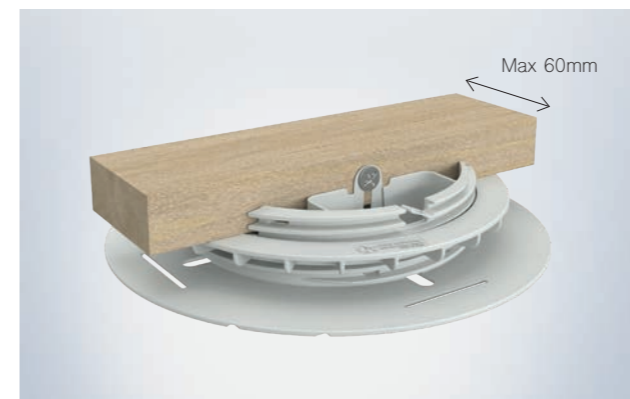
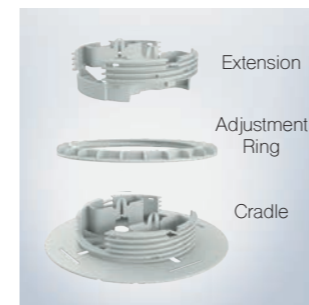

Mito Sizes

Description	Height
Mito Joist Cradle (incl. adjustment ring)	12-33mm
Mito Extension	33-56mm

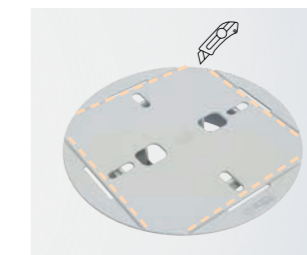

The base on Mito comes with pre-cut lines which allow the user to easily adapt the cradle for corners and walls, providing efficient installation and stability in every situation.

The Mito cradle is designed to suit decking joists up to 60mm in width, which are attached with simple wood screws positioned in correspondence with the appropriate central eyelets on the cradle.

KING PEDESTALS

This revolutionary patented pedestal is adjustable in height and allows the installer to choose between fixed or self-levelling base, just by twisting the converter located under the tower. The self-levelling base allows for maximum accuracy of adjustment and this additional function can correct level differences up to 5% of the surface.

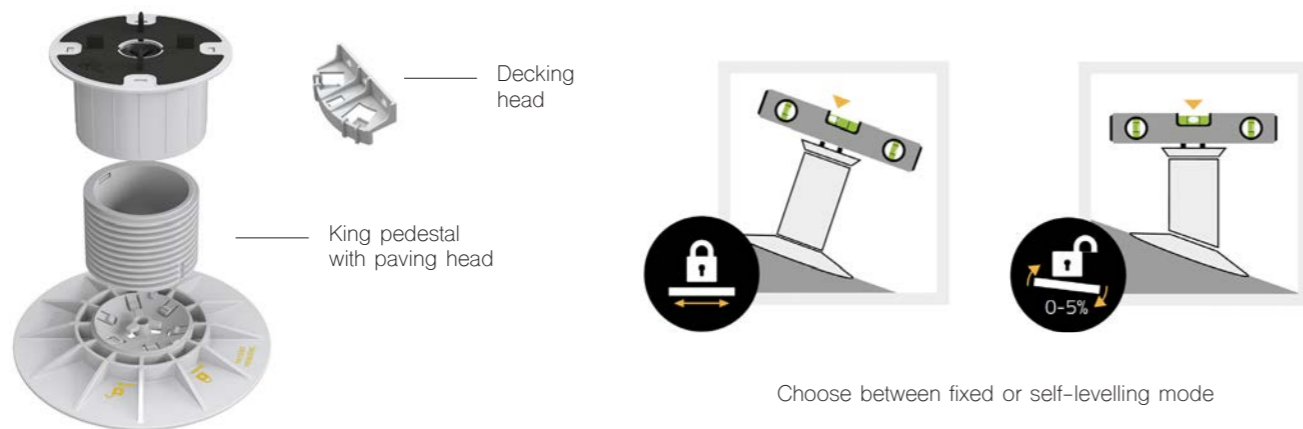

All of our pedestals are made up of 100% recycled high-quality polypropylene to create a sustainable and durable reinforced base and impact resistant screw. The King pedestal is the market's only recycled polypropylene support with a load capacity exceeding 1800kg.

KING PEDESTALS

Decking Pedestal

K1 30mm - K15 1089mm height

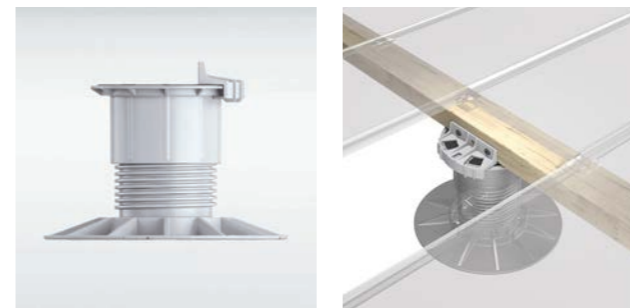

Paving Pedestal

K1 30mm - K15 1089mm height



King Pedestal Sizes

Decking/Paving

Composition	Height
P1 King Extension	113mm
K1	30mm-41mm
K2	41mm-63mm
K3	63mm-95mm
K4	95mm-152mm
K5	152mm-209mm
K6 (K4 + P1)	159mm-272mm
K7 (K5 + P1)	216mm-329mm
K8 (K4 + P1 + P1)	224mm-380mm
K9 (K5 + P1 + P1)	280mm-436mm
K10 (K5 + P1 + P1 + P1)	340mm-545mm

Can be stacked all the way to K15



P1 King Extension, 113mm height, allowing King pedestals to reach heights of 1500mm+.

QUEEN PEDESTALS

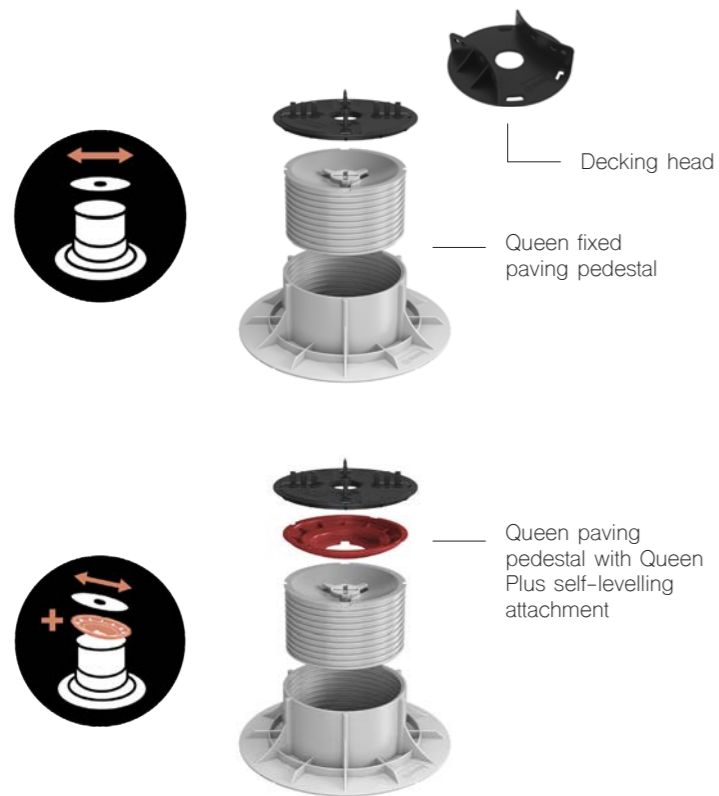

Queen is a reliable and durable raised floor support that is adjustable in height, with a fixed head. Ideal for multi-level renovations and projects that require operating at low heights. The Queen's minimum elevation height is just 21mm, through to 1000mm+.

With the application of a simple component between the screw and head, the Queen Plus attachment offers the option of self-levelling at the head to correct slopes of up to 5%. This transitions the Queen pedestal from fixed to a simple and practical self-levelling support.

QUEEN PEDESTALS

Decking Pedestal
Q1 21mm - Q15 1224mm height



Paving Pedestal
Q1 21mm - Q15 1224mm height



Queen Pedestal Sizes
Decking/Paving

Composition	Height
QTS Queen Short Extension	23mm-30mm
QTL Queen Long Extension	64mm-110mm
QUEEN PLUS Self-levelling head	7mm
Q1	21mm - 30mm
Q2	29mm - 44mm
Q3	43mm - 72mm
Q4	70mm - 126mm
Q5	124mm - 234mm
QP1 (Q1 + QUEEN PLUS)	28mm - 37mm
QP2 (Q2 + QUEEN PLUS)	36mm - 51mm
QP3 (Q3 + QUEEN PLUS)	50mm - 79mm
QP4 (Q4 + QUEEN PLUS)	77mm - 133mm
QP5 (Q5 + QUEEN PLUS)	131mm - 241mm

Can be stacked all the way to Q15/QP15

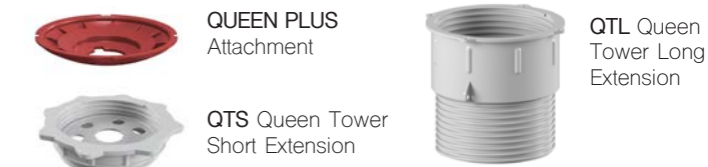

JUNIOR PEDESTALS

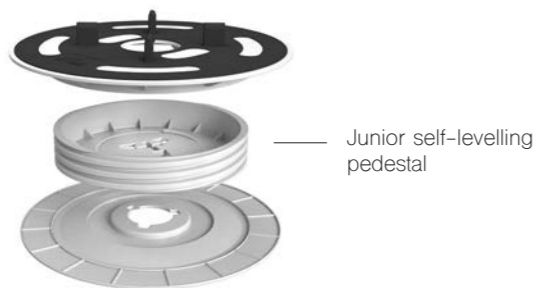

Junior self-levelling pedestal

Junior is an extremely low 12mm to 30mm support with a self-levelling head and functions without additional extensions. The movement of the screw runs between the head and the base which allows easy levelling of the floor and capable of adjusting slopes of up to 1.5%.

Junior Paving Pedestal
J1 12mm - J3 30mm height



Junior Pedestal Sizes
Suitable for paving systems only

Composition	Height
J1	12mm - 18mm
J2	18mm - 24mm
J3	24mm - 30mm

LORD MODULAR CRADLES

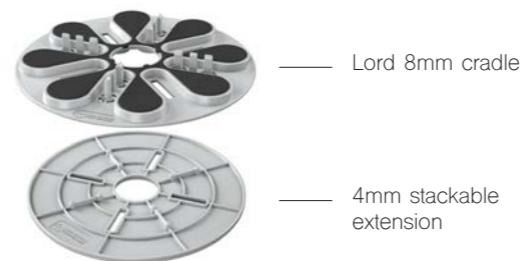

Lord 8mm cradle

4mm stackable extension

Lord cradles are fixed at 8mm and can be heightened by increments of 4mm when adding the Lord extension beneath the support. Lord is an effective solution in minor adjustment renovations and in all projects where very low heights are required.

Lord Paving Cradle
8mm height + 4mm height extension



Lord Sizes
Suitable for paving systems only

Composition	Height
Lord	8mm
Extension	4mm

Stack up to 3 extensions.

FORTE TIMBER FREE SUBSTRUCTURES

Using only the highest grade 100% recycled plastics we produce extremely strong and durable plastic joists/battens as an alternative to using a timber substructure. With profiles suitable for both decking and cladding these solutions are especially beneficial in the damp British climate where timber can be compromised in a matter of a few years.

We also offer a recycled aluminium support system. Extremely lightweight and durable – aluminium does not warp, shrink or swell like timber and remains perfectly straight throughout its 80+ year lifespan. The recycling process only takes up 5% of the energy used during its manufacturing and the quality of recycled aluminium is the same as that of new.



FORTE TIMBER FREE JOISTS, BATTENS & ACCESSORIES

Plastic Decking Joist
50mm x 50mm x 2400mm

ECOPL5050



Plastic Decking Joist
50mm x 125mm x 3000mm

ECOPL12550



Plastic Decking Post
100mm x 100mm x 3000mm

ECOPL100100



Plastic Cladding Battens
25mm x 50mm x 3000mm
20mm x 100mm x 2800mm

ECOPL2550 / ECOPL20100



Tech Rail Aluminium Joist
25mm x 70mm x 2000mm

ECOTECHTRAIL



For use in conjunction with our decking and paving pedestals

Aluminium Joist
40mm x 40mm x 3600mm

ECOALUJ4040



Cladding/Decking Tape
54/100mm width, 20m length

ECOTAPE54X20 / ECOTAPE100X20



Our weatherproof Cladding/Decking Tape preserves your timber cladding or decking frame to match the lifespan of our composite boards.

Made from recycled plastic, the tape is repositionable, self-seals, comes with a 25 year warranty and can even be applied to damp timber or below freezing temperatures.



NATURAL OAK
Forma Composite
Panel Cladding



FORMA®
COMPOSITE
PANEL
CLADDING

Ecoscape Forma composite panel cladding is a long lasting, low maintenance alternative to timber that can be used on various exterior projects; from home renovation to new build apartments, sunrooms or contemporary garden rooms.

Our cladding is made up of recycled high density polyethylene plastic and reclaimed wood fibres. With a durable polymer outer shell encapsulating the board, it forms an impermeable layer that offers protection from scratching and fading.

ARGENT
Forma Composite
Panel Cladding



Our tongue and groove capped cladding profiles are available in six colours, utilise a hidden fixing system and have a choice of 7 composite or 7 capped aluminium finishing trims.



SPICED OAK
Forma Composite
Panel Cladding



FORMA® COMPOSITE PANEL CLADDING

Havana

13mm x 142mm x 3600mm
Finished face 134mm

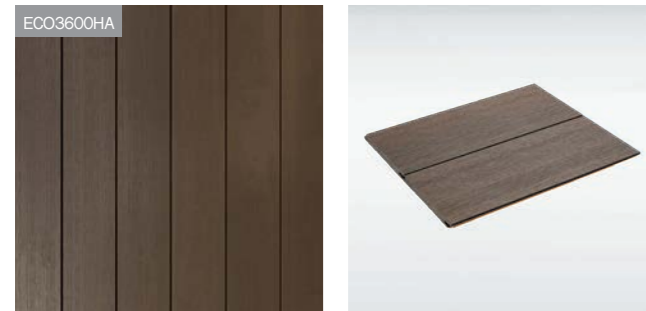

Silver Birch

13mm x 142mm x 3600mm
Finished face 134mm



Flint

13mm x 142mm x 3600mm
Finished face 134mm



Argent

13mm x 142mm x 3600mm
Finished face 134mm



Spiced Oak

13mm x 142mm x 3600mm
Finished face 134mm

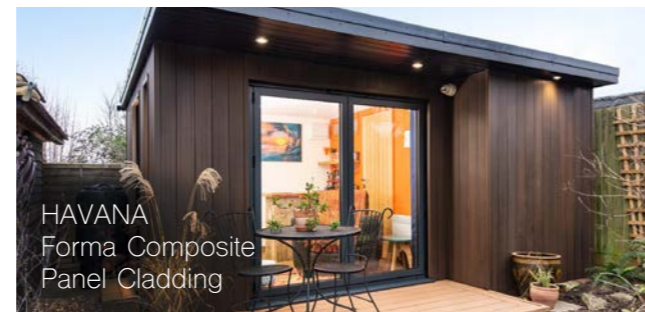
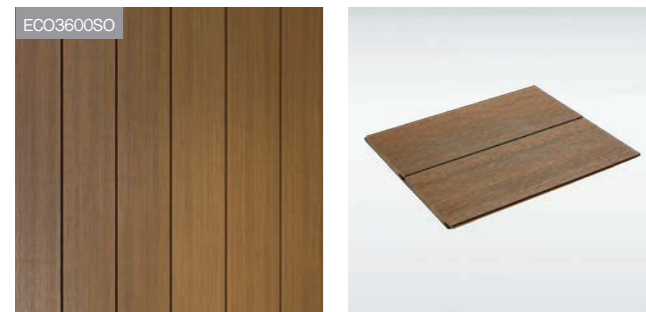

Natural Oak

13mm x 142mm x 3600mm
Finished face 134mm



Midnight

13mm x 142mm x 3600mm
Finished face 134mm



FORMA® COMPOSITE PANEL CLADDING TRIMS & ACCESSORIES

F Shape End Trim

47mm x 47mm x 3600mm
Finished face 25mm x 47mm

ECO4746XX



Angle Trim

40mm x 40mm x 3000mm
8mm trim thickness

ECO18XX3



Internal Corner Trim

72mm x 72mm x 3600mm
Finished face 24mm x 24mm

ECO7272XX



Panel Reveal Trim

47mm x 160mm x 3600mm
Finished face 25mm x 160mm

ECO47160XX



External Corner Trim

58mm x 58mm x 3600mm
Finished face 40mm x 40mm

ECO5858XX

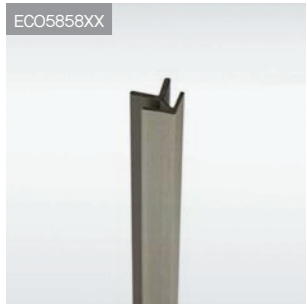

Joint Trim

24mm x 79mm x 3600mm
Finished face 40mm

ECO7924XX



Finishing Board

15mm x 80mm x 3600mm

ECO8015XX



Colour Coded Screws

40mm

Pack of 50: ECO09CS50XX40



Aluminium Starter Bar

3000mm

ECO702SB



Aluminium Cladding Clips

250pcs

ECO701CC



Plastic Pad

8mm x 18mm

ECO703PP

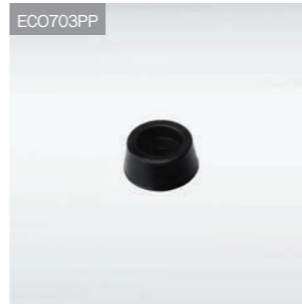

ECO704CW



Wood Screw

For Cladding Clip
250pcs

ECOLCCP



Locking Screw

For Cladding Clip
50pcs

MIDNIGHT Forma Composite Panel Cladding





FORMA®
COMPOSITE
SLATTED
CLADDING

LIGHT OAK
Forma Composite
Slatted Cladding

47



NATURAL OAK
Forma Composite
Slatted Cladding

Forma slatted cladding is the perfect addition to any garden, extension or renovation and can instantly transform any project into a luxury space.

This stunning material from the capped Forma range takes inspiration from natural timber cladding with no need to paint, stain or oil. All of our Forma cladding products come with a 25 year warranty.

Havana Forma Composite
Slatted Cladding



NEW



SPICED OAK
Forma Composite
Slatted Cladding

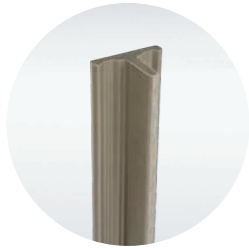

For cladding requirements longer than 3.6m, our **NEW** Joint Trim can be used to join the boards end-to-end, giving your project a seamless and professional finish.



SILVER BIRCH
Forma Composite
Slatted Cladding



Use our Reveal Trim to seamlessly frame deep windows and doorways in composite material

NEW

HAVANA
Forma Composite
Slatted Cladding

FORMA® COMPOSITE SLATTED CLADDING



Midnight

25mm x 120mm x 2500mm
25mm x 120mm x 3600mm

Finished face 112mm



Argent

25mm x 120mm x 2500mm
25mm x 120mm x 3600mm

Finished face 112mm



Silver Birch

25mm x 120mm x 2500mm
25mm x 120mm x 3600mm

Finished face 112mm



Havana

25mm x 120mm x 2500mm
25mm x 120mm x 3600mm

Finished face 112mm

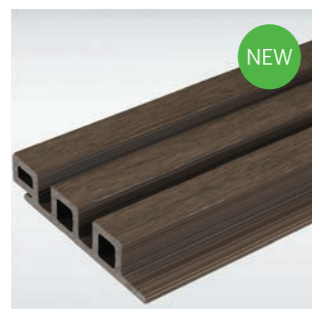
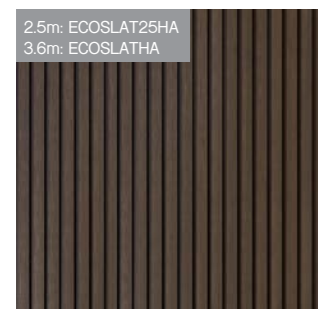

Spiced Oak

25mm x 120mm x 2500mm
25mm x 120mm x 3600mm

Finished face 112mm

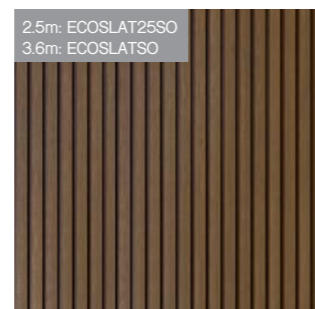

Natural Oak

25mm x 120mm x 2500mm
25mm x 120mm x 3600mm

Finished face 112mm



Light Oak

25mm x 120mm x 2500mm
25mm x 120mm x 3600mm

Finished face 112mm



FORMA® COMPOSITE SLATTED CLADDING TRIMS & ACCESSORIES

Slatted Corner Trim

45mm x 78mm x 3600mm
Finished face 29mm x 29mm

ECOSLATXXCT



Slatted End Trim

54mm x 75mm x 3600mm
Finished face 25mm x 54mm

ECOSLATXXET



Finishing Board

15mm x 80mm x 3600mm

ECO8015XX



Angle Trim

40mm x 40mm x 3000mm
8mm trim thickness

ECO18XX3



Slatted Reveal Trim

75mm x 160mm x 3600mm
Finished face 25mm x 160mm

ECOSLATXXRT



Joint Trim

35mm x 50mm x 3600mm
5mm trim thickness

ECOSLATXXJT

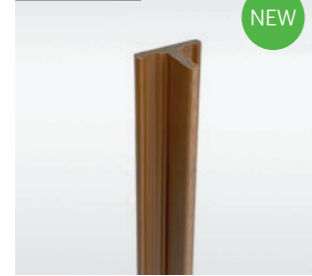

NEW

Aluminium Cladding Clips

250pcs

ECO701CC



Aluminium Starter Bar

3000mm

ECO702SB



ECO09CS50XX40



Colour Coded Screws

40mm, pack of 50

ECO703PP

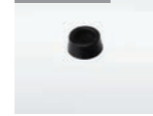

Plastic Pad

8mm x 18mm

ECO704CW



Wood Screw

For Cladding Clip
250pcs

ECOLCCP



Locking Screw

For Cladding Clip
50pcs

BENEFITS OF FORMA® CLADDING

- Environmentally conscious design using ethically sourced materials
- 95% recycled content
- FSC® certified
- Durable capping for UV and stain resistance
- Low maintenance – no need to paint, stain or seal
- Does not rot, warp or splinter
- Natural looking without many of the drawbacks of timber
- Easy installation system with invisible fixings
- 25 year warranty

FORMA® PRO ALUMINIUM CLADDING TRIMS

Developed as an alternative to our existing Forma Composite Slatted and Panel Cladding trims, these profiles combine durable aluminium alloy with a capped composite layer. They're designed to seamlessly complement our Forma Composite Cladding systems, simplify installation, and deliver a superior customer experience.

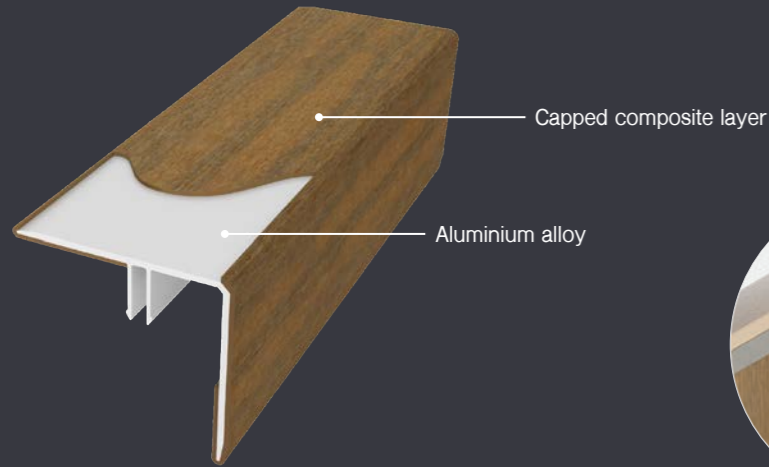

Installation example
Internal Panel Cladding
Corner Trim



Installation example
External Slatted Cladding
Corner Trim

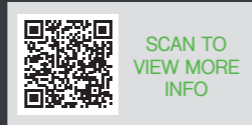

NEW

FORMA® PRO ALUMINIUM SLATTED CLADDING TRIMS

Slatted F Trim
51mm x 58mm x 3000mm



Slatted Ext. Corner Trim
65mm x 65mm x 3000mm



Slatted Int. Corner Trim
68mm x 45.5mm x 3000mm



Slatted Joint Trim
56mm x 16mm x 3000mm



Perf. Slatted Starter Trim
37.5mm x 40.5mm x 3000mm

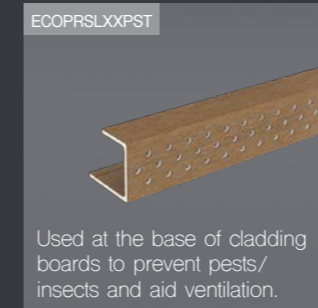

Used at the base of cladding boards to prevent pests/insects and aid ventilation.

J Trim
18mm x 40mm x 3000mm









Used for window and door lining

Flashing
81.5mm x 81.5mm x 3000mm



Ideal for window heads and sills

Colours available:

-  Midnight
-  Argent
-  Silver Birch
-  Havana
-  Spiced Oak
-  Natural Oak
-  Light Oak

FORMA® PRO ALUMINIUM PANEL CLADDING TRIMS

Panel F Trim
51mm x 46mm x 3000mm



Panel Ext. Corner Trim
65mm x 65mm x 3000mm



Panel Int. Corner Trim
68mm x 45.5mm x 3000mm



Panel Joint Trim
56mm x 16mm x 3000mm



Perf. Panel Starter Trim
25.5mm x 40.4mm x 3000mm









J Trim
18mm x 40mm x 3000mm



Flashing
81.5mm x 81.5mm x 3000mm



Colours available:

-  Midnight
-  Argent
-  Flint
-  Silver Birch
-  Havana
-  Spiced Oak
-  Natural Oak

FORMA® PRO ALUMINIUM CLADDING TRIMS



Installation example for window

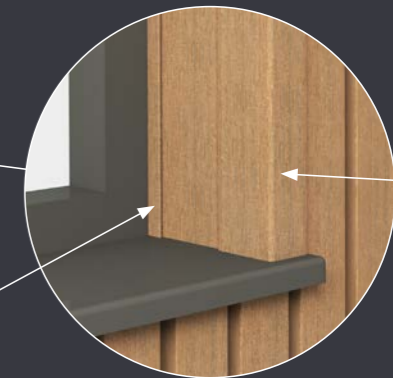
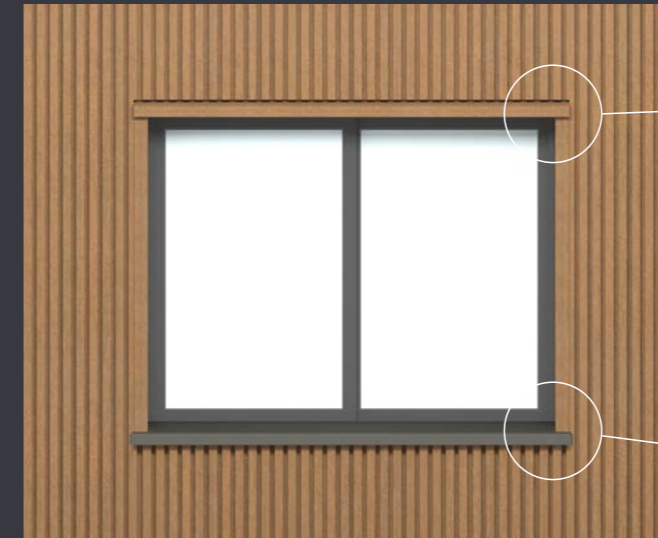

Flashing

F Trim

J Trim

FORMA® CLICK - COMPOSITE CLADDING FOR GRAD®



DARK OAK
Forma Click Combi

Forma Click is a composite cladding system developed in collaboration with Grad. It combines Ecoscape's distinctive composite profiles with Grad's precision engineered aluminium rail substructure to create a clean, click-in wall covering with no visible fixings. Designed with architects, contractors and specifiers in mind, the system delivers a precise and repeatable installation method suited to both residential and commercial applications.

Reduce Installation Time with 50%

Installation of Forma Click is streamlined by replacing conventional timber joists with Grad's durable aluminium rails and concealed clips. The boards simply click into place, creating smooth, uninterrupted surfaces while reducing installation time by up to 50 percent. The result is a faster build process and a refined finish that protects the integrity of the Forma profiles.



CHARRED WOOD
Forma Click Large

Developed to overcome the limitations of traditional face-fixed cladding, the Forma Click system eliminates visible screws while ensuring accurate alignment and consistent ventilation. The concealed Grad rail and clip structure creates smooth, uninterrupted surfaces that enhance façade precision and support reliable long term performance across a wide range of wall and ceiling applications.

Inspired by the look of natural timber, Forma Click delivers warmth and texture without the need for painting, staining, or oiling. Its durable, low maintenance composite construction is backed by a 25 year warranty, making it suitable for a wide range of exterior applications.

Sustainability is integral to the design, with recycled and recyclable materials and a system that allows boards to be removed and reused, supporting circular construction and long term environmental performance.



Forma Click composite cladding boards are available in three widths and five colour options. The boards can be installed vertically, horizontally or at an angle.



NEW

Grad® Rail Options

Combi - For mix of 45mm (S), 64mm (M) and 119mm (L) boards*



* Pre-set pattern, see installation guide for more info.

Small - For 45mm (S) boards



Medium - For 64mm (M) boards

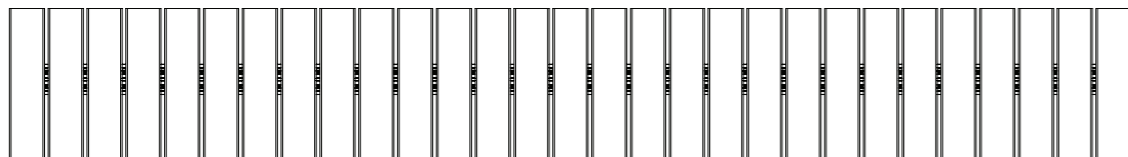

Large - For 119mm (L) boards

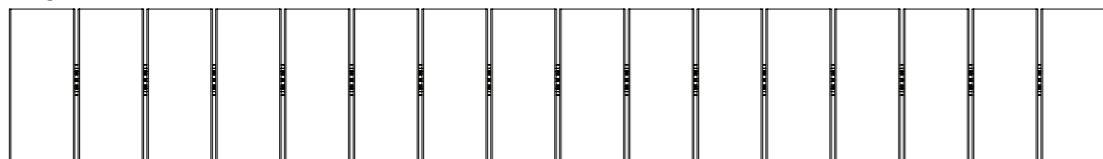

Combi Rail

The Grad Combi Rail is engineered to accommodate the mixed-width Combi configuration, allowing 45mm (S), 64mm (M) and 119mm (L) Forma Click boards to be installed in a pre-set pattern. This creates architectural variation while maintaining precise 5mm shadow gaps and consistent alignment.

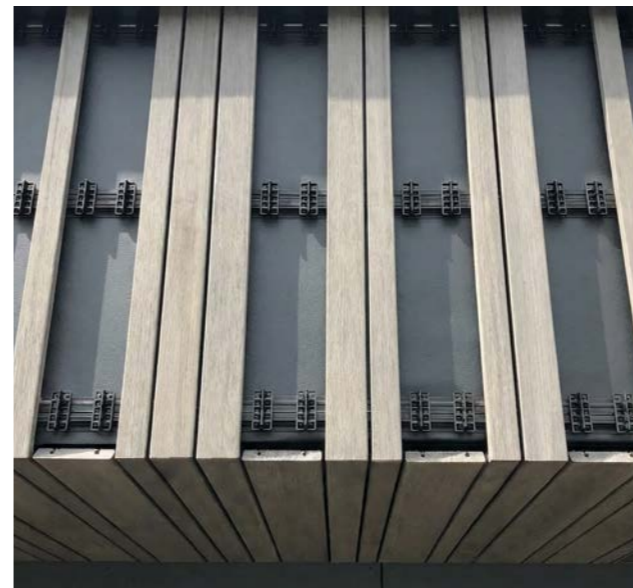

SILVER BIRCH
Forma Click Combi

FORMA® CLICK - COMPOSITE CLADDING FOR GRAD®



Silver Birch

Available in 3 widths in 2500mm and 3600mm lengths



Natural Oak

Available in 3 widths in 2500mm and 3600mm lengths



Argent

Available in 3 widths in 2500mm and 3600mm lengths



Dark Oak

Available in 3 widths in 2500mm and 3600mm lengths



Charred Wood

Available in 3 widths in 2500mm and 3600mm lengths



Forma Click is available in a striking black charred finish inspired by **Japanese Yakisugi (Shou Sugi Ban)**. This high sheen surface replicates the look of burnt timber while delivering the durability and low maintenance of modern composite materials.



SCAN FOR MORE INFO

Additional Options

Alongside our stocked range, you can choose from 15 additional colours and lengths up to 5400mm, available to order with a minimum of 250m²+ (profile dependent) and a 14-16 week lead time.

SIZES

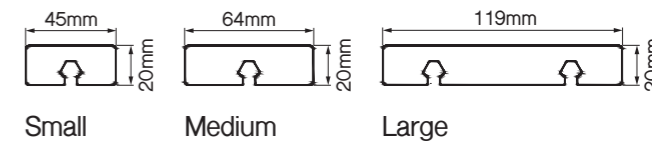

2500mm lengths			
Colour	Small	Medium	Large
Silver Birch	ECOGDAS25SB	ECOGDAM25SB	ECOGDAL25SB
Natural Oak	ECOGDAS25NO	ECOGDAM25NO	ECOGDAL25NO
Charred Wood	ECOGDAS25CW	ECOGDAM25CW	ECOGDAL25CW
Argent	ECOGDAS25AR	ECOGDAM25AR	ECOGDAL25AR
Dark Oak	ECOGDAS25DO	ECOGDAM25DO	ECOGDAL25DO

3600mm lengths			
Colour	Small	Medium	Large
Silver Birch	ECOGDAS36SB	ECOGDAM36SB	ECOGDAL36SB
Natural Oak	ECOGDAS36NO	ECOGDAM36NO	ECOGDAL36NO
Charred Wood	ECOGDAS36CW	ECOGDAM36CW	ECOGDAL36CW
Argent	ECOGDAS36AR	ECOGDAM36AR	ECOGDAL36AR
Dark Oak	ECOGDAS36DO	ECOGDAM36DO	ECOGDAL36DO

To calculate material required per sqm, please see installation guide.

GRAD® CLADDING RAIL

Flat Rail

Used for installing exterior cladding, soffits, roofing, ceilings, and interior panelling. Includes standard Grad clips, pre-fitted in fixed positions for easy installation.

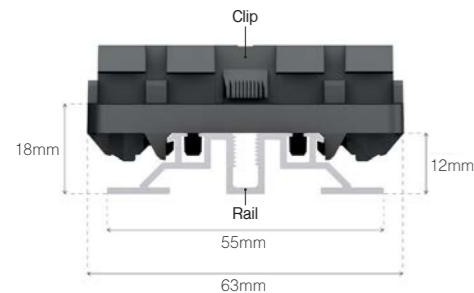

Grad Flat Rail sizes available			
Size	Code	Clip spacing	Rail dimensions (excl clip)
Small	ECOGDRS	51mm (for 45mm boards)	12mm x 55mm x 1989mm
Medium	ECOGDRM	69mm (for 64mm boards)	12mm x 55mm x 2001mm
Large	ECOGDRL	56mm & 68mm (for 119mm boards)	12mm x 55mm x 1984mm
Combi	ECOGDVA	Combi (mixes all three board sizes)	12mm x 55mm x 1969mm



Small rail - Recurrent 51mm clip spacing for 39 x 45mm boards

51mm



Medium rail - Recurrent 69mm clip spacing for 29 x 64mm boards

69mm



Large rail - Alternating 56mm & 68mm clip spacing for 16 x 119mm boards (2 clips used per board)

68mm

56mm



Combi rail - Mixed board spacing for 8 x 45mm, 8 x 64mm and 8 x 119mm boards

To calculate material required per sqm, please see [installation guide](#).



ARGENT
Forma Click Medium

NEW

GRAD® RAIL ACCESSORIES

Replacement Clip

For replacement of damaged clips, 50pcs

ECOGDRGC



Half Clip

For skirting and narrowing boards, 50pcs

ECOGDCLH



Angle Clip

For installation of angled boards, 50pcs

ECOGDCLA



Sliding Clip

For board spacing adjustments, 50pcs

ECOFDCLS



Incl. M5 x12 Screws

Clip Grip

Prevents board slippage, 50pcs

ECOGDCLG



Rail Connector

Links sections of Flat Rail, 20pcs

Small: ECOGDTLKS
Medium: ECOGDTLKM
Large: ECOGDTLKL



Removal Tool

For removing cladding boards, pair

ECOGDK



Rubber Strip

2000mm x 55mm x 4mm, pack of 2

ECOGDRBST



BENEFITS OF

FORMA® CLICK Composite Cladding For Grad®

- **Reduce Installation Time By 50%** - Pre-grooved boards effortlessly click into Grad aluminium rails for speed
- **Precision Spacing** - Factory set clips guarantee accuracy with no on-site adjustment needed
- **Installation Flexibility** - With three board widths and four Grad rails, designers are free to create a wide range of façade for maximum visual impact
- **Versatile Applications** - Suitable for installation on any surface from house walls, walls, and ceilings to garden rooms, screens and more
- **Perfect Finish With No Visible Fixing** - No damage to the surface of the Forma Click composite boards
- **Low Maintenance** - No painting, staining or sealing required
- **25 Year Warranty** - Durable, UV stable capped composite boards that will look beautiful for years to come

NEW

FORMA® COMPOSITE GARDEN SHED



ARGENT
Forma Composite Garden Shed Small

FORMA® COMPOSITE GARDEN SHED

COLOURS AVAILABLE

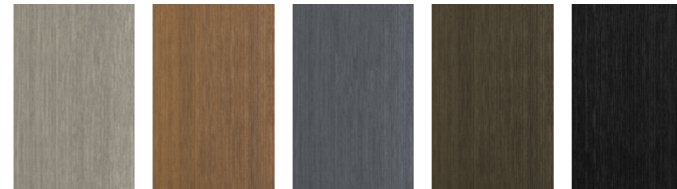

Silver Birch

Spiced Oak

Argent

Dark Oak

Onyx

Our new Forma Composite Garden Sheds are the perfect blend of style and strength. Built from premium capped WPC composite and hybrid aluminium capped profiles, they're durable, weatherproof, and designed for easy installation. Choose from 3 sizes and 5 versatile colour options to create a shed that's as practical as it is stylish.

SIZES AVAILABLE



Small



Medium



Large

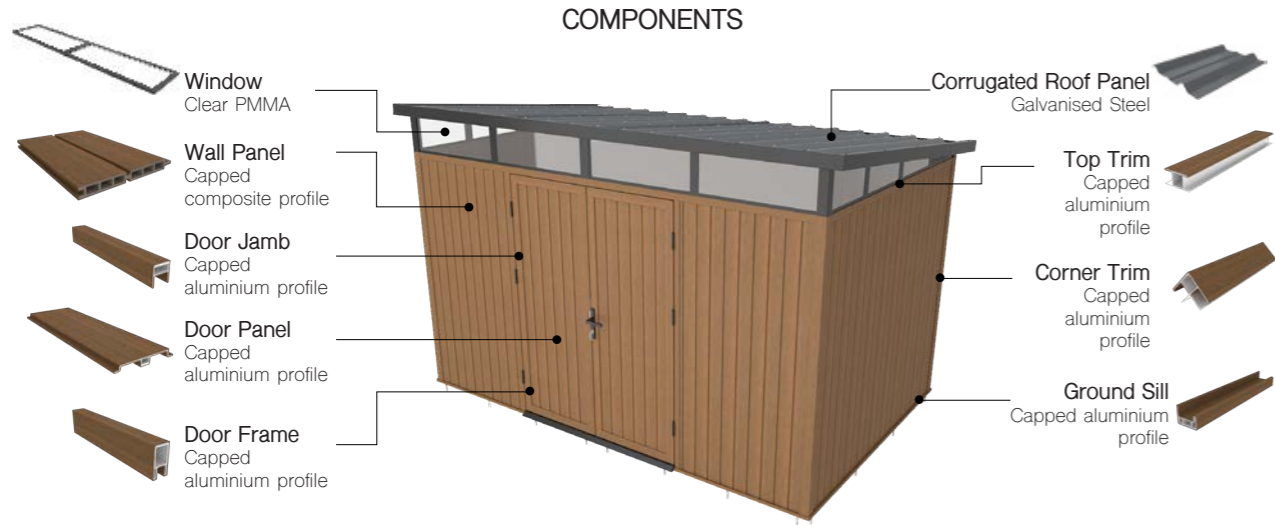

Product codes			
Shed Colour	Small 2220mm wide	Medium 2830mm wide	Large 3340mm wide
Silver Birch	ECOSHEDSB222	ECOSHEDSB283	ECOSHEDSB334
Spiced Oak	ECOSHEDSO222	ECOSHEDSO283	ECOSHEDSO334
Argent	ECOSHEDAR222	ECOSHEDAR283	ECOSHEDAR334
Dark Oak	ECOSHEDDO222	ECOSHEDDO283	ECOSHEDDO334
Onyx	ECOSHEDOX222	ECOSHEDOX283	ECOSHEDOX334

FLOORING OPTIONS

Cut to size for each shed, for easy install.



NEW



BENEFITS OF FORMA® COMPOSITE GARDEN SHED

- 25 Year Warranty
- UV Stable
- Stain Resistant
- Mold & Mildew Resistant
- Recycled Materials

ONYX
Forma Composite
Garden Shed Large

CLARITY® COMPOSITE FENCING & GATES



Ecoscope's range of composite fencing and gates are an innovative modular WPC profile which stack to create any desired height. This creates a bespoke, long lasting, low maintenance alternative to timber fence panels.

Fence boards can either be retrofitted between existing fence posts or can be utilised in the fully composite post system; the perfect way to transform any garden into a luxury space.

This versatile system offers flexibility and style but also maintains the same environmentally friendly ethos as our other composite ranges and is made up of the same high quality recycled HDPE plastic and reclaimed wood fibres.

CHARCOAL
Clarity Composite
Fencing & Gate



GRAPHITE
Clarity Composite Fencing

CLARITY® COMPOSITE FENCE BOARDS



Walnut

45mm x 157mm x 1830mm



Graphite

45mm x 157mm x 1830mm



Charcoal

45mm x 157mm x 1830mm



NOTE: Lighter Clarity boards will show greater colour settling due to smaller quantities of dye and greater UV exposure to the natural wood fibres. After 3 months of UV exposure colour remains consistent.

CLARITY® COMPOSITE FENCE COMPONENTS

Top Board
45mm x 139mm x 1830mm



End Post
125mm x 125mm x 1940/3000mm



Inter Post
125mm x 125mm x 1940/3000mm



Corner Post
125mm x 125mm x 1940/3000mm



Post Cap
23mm x 145mm x 145mm



Aluminium Bottom Rail
45mm x 52mm x 1830mm



Black Steel Fence Base Plate with Fixing Bolts & Caps
125mm x 190mm x 900mm



Steel Post Insert
55mm x 55mm x 1940/3000mm



Plastic Holder / Security Clip
Aluminium bottom rail support (pair)



Full Top Cap
23mm x 145mm x 4000mm

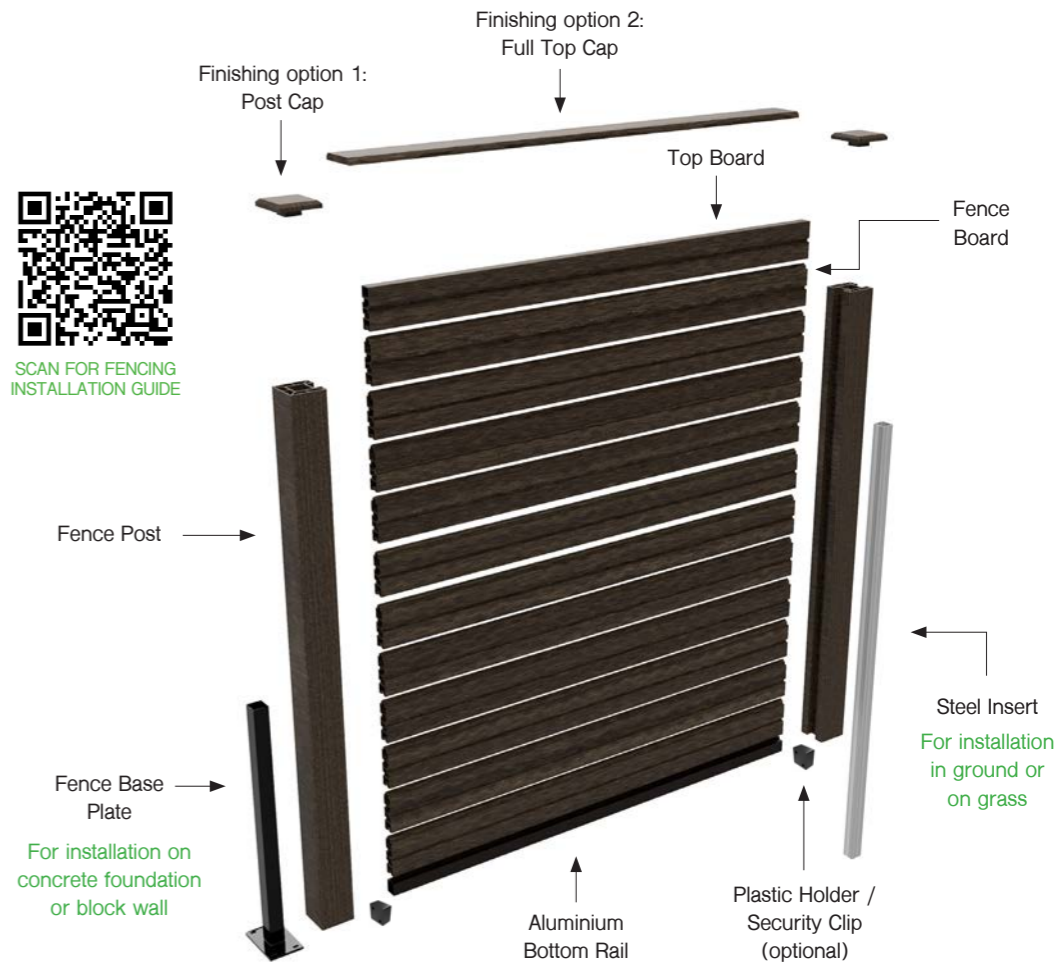

CLARITY® COMPOSITE GATES

“4ft” Charcoal/Graphite/Walnut
52mm x 900mm x 1220mm

ECOCXX122



Graphite shown

“5ft” Charcoal/Graphite/Walnut
52mm x 900mm x 1520mm

ECOCXX152



Walnut shown

“6ft” Charcoal/Graphite/Walnut
52mm x 900mm x 1820mm

ECOCXX182



Charcoal shown



SCAN TO VIEW
OUR COMPOSITE
GATES VIDEO

Our preassembled gates come with a black powder coated aluminium frame and are fitted with high quality hinges, handle and lock, ready to hang onto Ecoscape fence posts or equivalent. The gates are dual sided with 63mm battens on one side and 38mm battens on the other.

BENEFITS OF COMPOSITE FENCING & GATES

- Modular system allowing for multiple design options
- 3 natural colours with matching gates in 4ft, 5ft & 6ft heights
- Environmentally conscious design using ethically sourced materials
- 95% recycled content*
- FSC® certified*
- Suitable for new project or retrofit between existing concrete posts
- Quick and easy installation system
- Strong and durable, storm resistant, 45mm thick boards
- 20 year warranty*



NEW

EASY FIT NON-COMBUSTIBLE ALUMINIUM DECKING SYSTEM

SEPIA BROWN
Easy Fit Non-Combustible
Aluminium Decking

Ecoscope's Easy Fit Aluminium Decking System is a non-combustible, A2-rated solution designed for high-rise balconies, terraces, walkways, and decking areas. Manufactured from 6063 T6-grade aluminium and finished with a durable, slip-resistant Qualicoat Class 2 coating, it combines long-lasting performance with a refined, modern aesthetic and clean hidden fixings. Made with recycled content and fully recyclable at the end of its life, it's a sustainable, low-maintenance choice for contemporary outdoor design.



BEIGE GREY
Easy Fit Non-Combustible
Aluminium Decking

The collection is offered in five contemporary colours, with the flexibility to specify bespoke RAL shades for a tailored finish. The design delivers a bold architectural statement, adding striking contrast and a sleek finish to any outdoor space. For complete compliance and a seamless fit, pair the decking with our non-combustible pedestals and aluminium joists.



ANTHRACITE
Easy Fit Non-Combustible
Aluminium Decking

EASY FIT NON-COMBUSTIBLE ALUMINIUM DECKING SYSTEM COMPONENTS

NEW

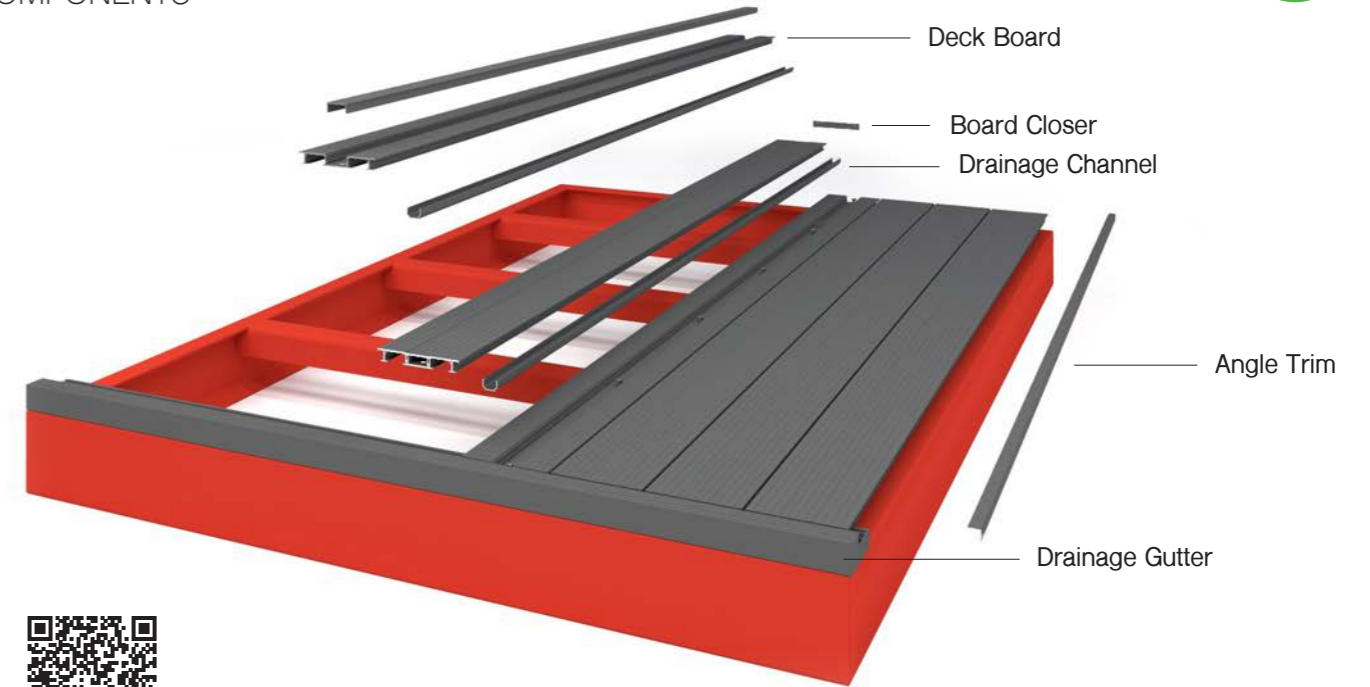

SCAN FOR
MORE INFO

EASY FIT ALUMINIUM DECKING

Jet Black RAL 9005
20mm x 150mm x 3600mm



Anthracite Grey RAL 7016
20mm x 150mm x 3600mm



Dusty Grey RAL 7037
20mm x 150mm x 3600mm



Sepia Brown RAL 8014
20mm x 150mm x 3600mm



Beige Grey RAL 7006
20mm x 150mm x 3600mm



Bespoke RAL
20mm x 150mm x 3600mm/6000mm

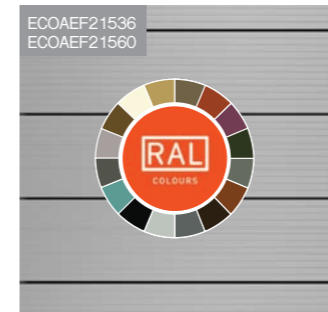

Mill finish board, can be powder coated in any RAL colour on request.



JET BLACK
Easy Fit Aluminium Decking

EASY FIT ALUMINIUM DECKING ACCESSORIES

Deck Board Closer

3mm x 20mm x 150mm

ECOAECL2015XX



Angle Trim

20mm x 20mm x 3600mm

ECOAE20A36XX



Aluminium Joist

50mm x 50mm x 3600mm

ECOADJ5050BK



Aluminium Joist

25mm x 50mm x 3600mm

ECOADJ5025BK



Drainage Channel

17mm x 27mm x 3600mm

ECOAECH36XX

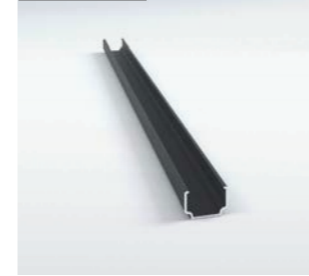

Colour Coded Screws

For discreet fixing of board closers and angle trims.

ECOAES4217XX



Bolts

For use with Deck Boards and Ecoscape Aluminium Joists

ECOAEBOLT



Self-drilling Screws

For fixing joists to pedestals

ECOAEJSCRW



Flanged Screws

For fixing Deck Boards to steel

ECOAEFSCRW



Drainage Gutter

45mm x 140mm x 3600mm

ECOAEGU36XX



BENEFITS OF EASY FIT NON-COMBUSTIBLE ALUMINIUM DECKING

- Non-Combustible (A2-s1,d0 to BS EN 13501)
- 6063 T6-grade Aluminium
- Low Slip Potential
- Recycled Content
- 100% Recyclable
- 5 Stocked Colours + Bespoke RAL Option
- Maintenance-free
- Hidden Fixings
- Easy to Install

PYRA A2 NON-COMBUSTIBLE PEDESTALS

PYRA A2 Self-Levelling Non-Combustible Joist Pedestal with Easy Fit Aluminium Decking, 25mm x 50mm Aluminium Joist and stainless steel 25mm Straight Bracket and Bolts.

Our A2-rated non-combustible pedestals provide a safe, durable foundation for raised decking and paving. Made from galvanised steel and fire-safe materials, they meet strict compliance standards for residential and commercial use. Available in adjustable and self-levelling options, they ensure quick, accurate installation and long-term stability—delivering a secure base and a professional finish across terraces, balconies, podiums and roof decks.



SCAN FOR
MORE INFO

NEW

PYRA A2 NON-COMBUSTIBLE JOIST PEDESTALS

Height Adjustable Joist Pedestal

Corrosion-resistant steel, black

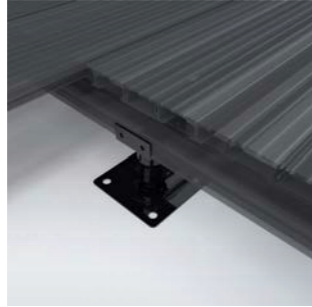

Sizes available	
Code	Height range
ECOSJP01	26mm-33mm
ECOSJP02	32mm-44mm
ECOSJP03	42mm-63mm
ECOSJP04	62mm-100mm
ECOSJP05	92mm-160mm
ECOSJP06	152mm-270mm
ECOSJP07	262mm-490mm

Self-levelling Joist Pedestal

Corrosion-resistant steel, black

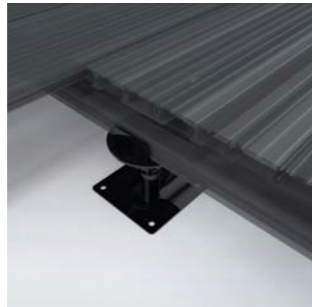

Sizes available	
Code	Height range
ECOSLJP01	40mm-50mm
ECOSLJP02	46mm-64mm
ECOSLJP03	64mm-88mm
ECOSLJP04	86mm-130mm
ECOSLJP05	130mm-200mm
ECOSLJP06	190mm-320mm
ECOSLJP07	305mm-545mm

PYRA A1 Height Adjustable Joist Cradle

Designed for low profile
flooring build up height.



Sizes available:
10-30mm
(ECOSC01)
or 30-55mm
(ECOSC02)

NEW



PYRA A2 Height Adjustable Non-Combustible Joist Pedestal,
25mm x 50mm Aluminium Joist and stainless steel 25mm Angle Bracket and Bolts.

PYRA A2 NON-COMBUSTIBLE PAVING PEDESTALS

Height Adjustable Paving Pedestal

Corrosion-resistant steel, black

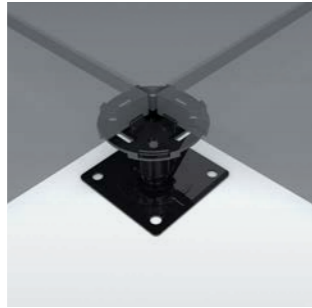

Sizes available	
Code	Height range
ECOSP01	26mm-33mm
ECOSP02	32mm-44mm
ECOSP03	42mm-63mm
ECOSP04	62mm-100mm
ECOSP05	92mm-160mm
ECOSP06	152mm-270mm
ECOSP07	262mm-490mm

Self-levelling Paving Pedestal

Corrosion-resistant steel, black

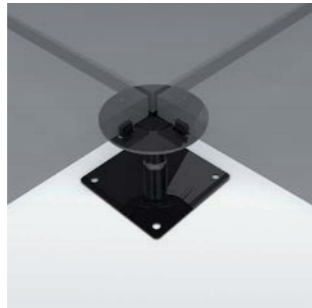

Sizes available	
Code	Height range
ECOSLSP01	40mm-50mm
ECOSLSP02	46mm-64mm
ECOSLSP03	64mm-88mm
ECOSLSP04	86mm-130mm
ECOSLSP05	130mm-200mm
ECOSLSP06	190mm-320mm
ECOSLSP07	305mm-545mm

NON-COMBUSTIBLE PEDESTALS ACCESSORIES



Angled Bracket

For 25mm joist, stainless steel



Angled Bracket

For 50mm joist, stainless steel



Concealed Paving Anchor

For paving, stainless steel

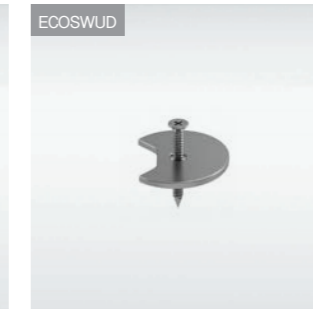

Spreader Plate

Prevents damage to roof membranes



Straight Bracket

For 25mm joist, stainless steel



Straight Bracket

For 50mm joist, stainless steel



Perimeter Spacer

For paving, stainless steel

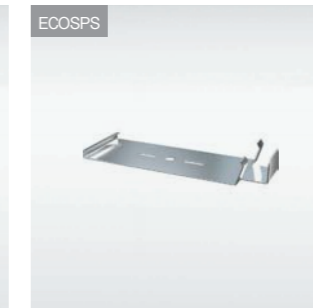

BALUSTRADE SYSTEMS

NEW

6021 SERIES
Silver U Channel Balustrade
System with Handrail

FRAMELESS BALUSTRADE SYSTEMS

6000 Series U Channel
Top Mount, Silver



6020 Series U Channel
Top Mount, Silver



6021 Series U Channel
Side Mount, Silver



Titan Spigot
Top Mount, Silver



6500 Series U Channel
Top Mount, Silver, for parapet



6501 Series U Channel
Side Mount, Silver, for parapet



Skyforce Juliet Balcony
Top / Side Mount, Black



SEE COMPARISON OVERLEAF

FRAMELESS BALUSTRADE SYSTEM COMPARISON

Product range	Mounting type	Finish	Material	Handrail available	Usage	Load rating†	Length	Extensive accessories range
6000 Series U Channel	Top	Silver (natural anodised) Black (powder coated)	Aluminium	Yes	Residential & low traffic spaces	0.74 kN	2500mm 5000mm	x
6020 Series U Channel	Top	Silver (natural anodised) Black (powder coated)	Aluminium	Yes	Residential, commercial & public spaces	1.5kN	2500mm 5000mm	Yes
6021 Series U Channel	Side	Silver (natural anodised) Black (powder coated)	Aluminium	Yes	Residential, commercial & public spaces	1.5kN	2500mm 5000mm	Yes
6500 Series U Channel	Top	Silver (natural anodised) Black (powder coated)	Aluminium	Yes	Parapet walls	0.74kN	5000mm	x
6501 Series U Channel	Side	Silver (natural anodised) Black (powder coated)	Aluminium	Yes	Parapet walls	0.74kN	2500mm 5000mm	x
Titan Spigot	Top	Silver (satined) Black (powder coated)	Marine Grade Stainless Steel	x	Residential, commercial, poolside & coastal environments	0.74kN	n/a	x
Skyforce Juliet Balcony	Top/Side	Silver (natural anodised) Black (powder coated)	Aluminium	Yes	Plastic, aluminium, wooden & metal frames	1.5kN	n/a	Yes

† Maximum load rating possible for this system, subject to installation method and glass thickness.

COMPOSITE BALUSTRADE SYSTEM

CLARITY® - Composite Balustrade
Available in Charcoal, Walnut & Graphite

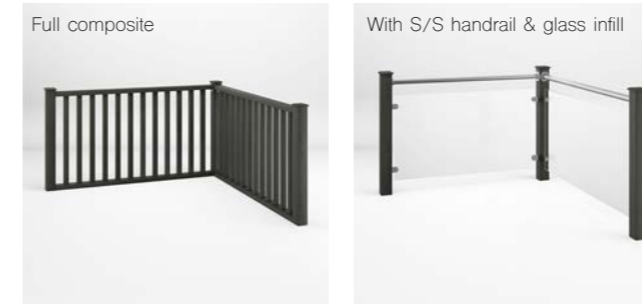

RAILING

liteRAIL Aluminium
Black finish, 1000mm height

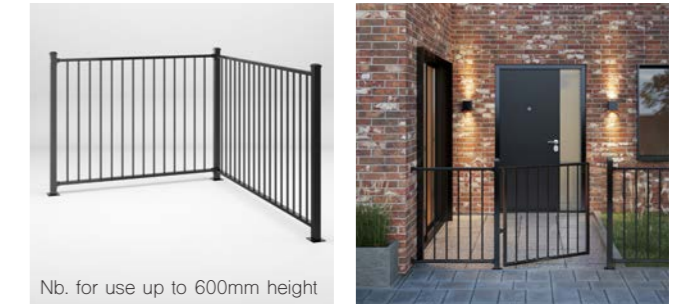

forzaRAIL Galvanized Steel
Textured black finish, 1100mm height

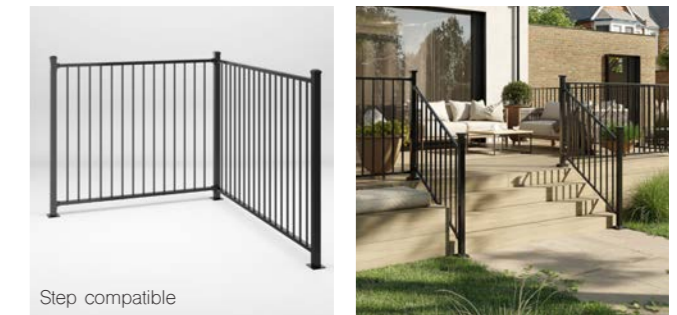

METAL POST BALUSTRADE SYSTEMS

VITRA - Stainless Steel with Glass

Brushed finish, available base fixed or side fixed

With handrail



Without handrail



MODA - Aluminium with Glass

Satin anodised finish, available base fixed or side fixed

With handrail



Without handrail



CORDA - S/S with Wire

Brushed finish



SCAN TO VIEW
BALUSTRADE
BROCHURE



OUTDOOR KITCHENS



TAUPE
Outdoor Kitchen

Our outdoor kitchen range is made from durable powder-coated aluminium and 100% recycled polywood, combining long-lasting performance with sustainable design. Available in four versatile colour schemes, this modular collection includes a sink unit, trolley, cabinet, and worktop, each with practical under-counter storage.

Each unit can be positioned independently to create a tailored layout, and all come complete with a grey weatherproof cover.

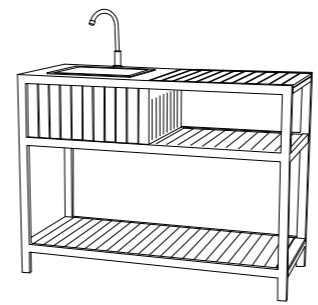

Sink Unit
Including a high quality stainless steel sink and a single lever black tap.
H:95cm x W:127cm x D:53cm

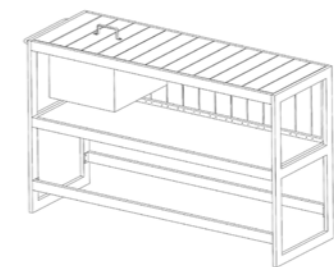

Worktop
With built in ice bucket & towel rail and hooks on the side
H:91cm x W:146cm x D:50cm

SET OF 3 UNITS



Cabinet
With cupboard doors & gold effect knobs
H:91cm x W:70cm x D:50cm



Trolley
With bottle holders, wheels & handle
H:91cm x W:84cm x D:50cm

OUTDOOR KITCHEN UNITS

Sink Unit - Smoke

Incl. sink & tap

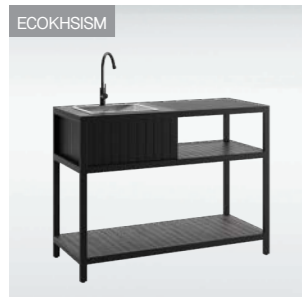

Set of 3 Units - Smoke

Worktop unit with ice bucket (1), Cabinet (2) & Trolley (3)



Sink Unit - Taupe

Incl. sink & tap



Set of 3 Units - Taupe

Worktop unit with ice bucket (1), Cabinet (2) & Trolley (3)



Sink Unit - Oak

Incl. sink & tap



Set of 3 Units - Oak

Worktop unit with ice bucket (1), Cabinet (2) & Trolley (3)

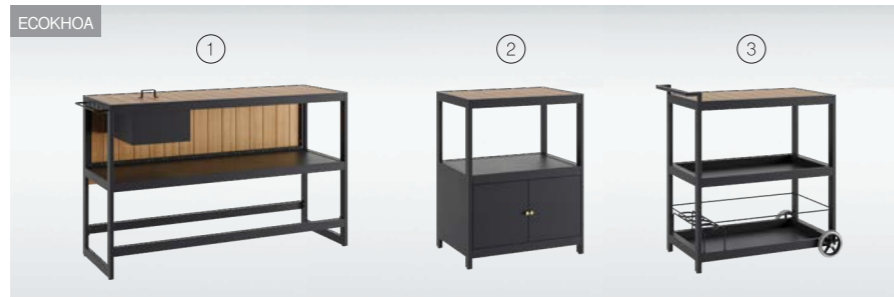

Sink Unit - Cotton

Incl. sink & tap



Set of 3 Units - Cotton

Worktop unit with ice bucket (1), Cabinet (2) & Trolley (3)



BIN STORAGE

Hide your bins away with our discreet galvanised steel units. Available with a spring opening lid with a hook to lift the bin lid, or a planter top. Both options include stainless steel handles with a hidden lock, magnets for door closure and holes on both sides to connect multiple units together. Available in two colour options.



WOODGRAIN & CHARCOAL
Double bin storage with planter top

BIN STORAGE WITH PLANTER:



The planter roof offers the perfect opportunity to add some greenery to enhance your outdoor area. The chain mechanism enables effortless tipping of the waste bin, facilitating disposal without removing it from storage.

BIN STORAGE WITH SOFT CLOSE LID:



The lid is equipped with gas springs and pressure dampers, along with a hook and chain system for effortless lifting and convenient waste disposal.

FEATURES:

- Sturdy and durable
- Weatherproof and corrosion free
- Body made of powdercoated galvanised steel
- Option of charcoal finish (RAL7021) or charcoal with woodgrain effect doors
- Stainless steel door handles with hidden locks
- Magnets to hold doors in place securely
- Individual modules with holes on the sides for connecting multiple units
- Suitable for 60L, 120L & 240L wheelie bins.

DIMENSIONS	CM
Single with planter	W68 x D80 x H124
Double with planter	W132 x D80 x H124
Triple with planter	W200 x D80 x H124
Quadruple with planter	W264 x D80 x H124
Single with lid	W68 x D80 x H116
Double with lid	W132 x D80 x H116
Triple with lid	W200 x D80 x H116
Quadruple with lid	W264 x D80 x H116

BIN STORAGE

Single Bin Storage
with Lid
Charcoal

ECOBLS



Double Bin Storage
with Lid
Charcoal

ECOBLCD



Triple Bin Storage
with Lid
Charcoal

ECOBLC



Quadruple Bin Storage
with Lid
Charcoal

ECOBLCQ



Single Bin Storage
with Planter
Charcoal

ECOBPCS



Double Bin Storage
with Planter
Charcoal

ECOBPCD



Triple Bin Storage
with Planter
Charcoal

ECOBPCT



Quadruple Bin Storage
with Planter
Charcoal

ECOBPCQ



Single Bin Storage
with Lid
Woodgrain & Charcoal

ECOBLWS



Double Bin Storage
with Lid
Woodgrain & Charcoal

ECOBLWD



Triple Bin Storage
with Lid
Woodgrain & Charcoal

ECOBLWT



Quadruple Bin Storage
with Lid
Woodgrain & Charcoal

ECOBLWQ



Single Bin Storage
with Planter
Woodgrain & Charcoal

ECOBPWS



Double Bin Storage
with Planter
Woodgrain & Charcoal

ECOBPWD



Triple Bin Storage
with Planter
Woodgrain & Charcoal

ECOBPWT



Quadruple Bin Storage
with Planter
Woodgrain & Charcoal

ECOBPWQ





MIDNIGHT
Forma Composite Slatted Cladding

CHARCOAL
Triple Bin Storage with Planter

ACCESS OUR ONLINE RESOURCES

Scan the QR codes to view our PDF guides and videos.



DECKING
GUIDE



PANEL CLADDING
GUIDE



SLATTED CLADDING
GUIDE



FORMA CLICK
GUIDE



FENCING
GUIDE



GATES
GUIDE



HELPFUL
VIDEOS



SKETCHUP
3D WAREHOUSE



ANTHRACITE
Easy Fit Non-Combustible Aluminium Decking

ecoscape.co.uk
01706 364 637
sales@ecoscape.co.uk

Front cover: Forma Click Natural Oak Composite Cladding