

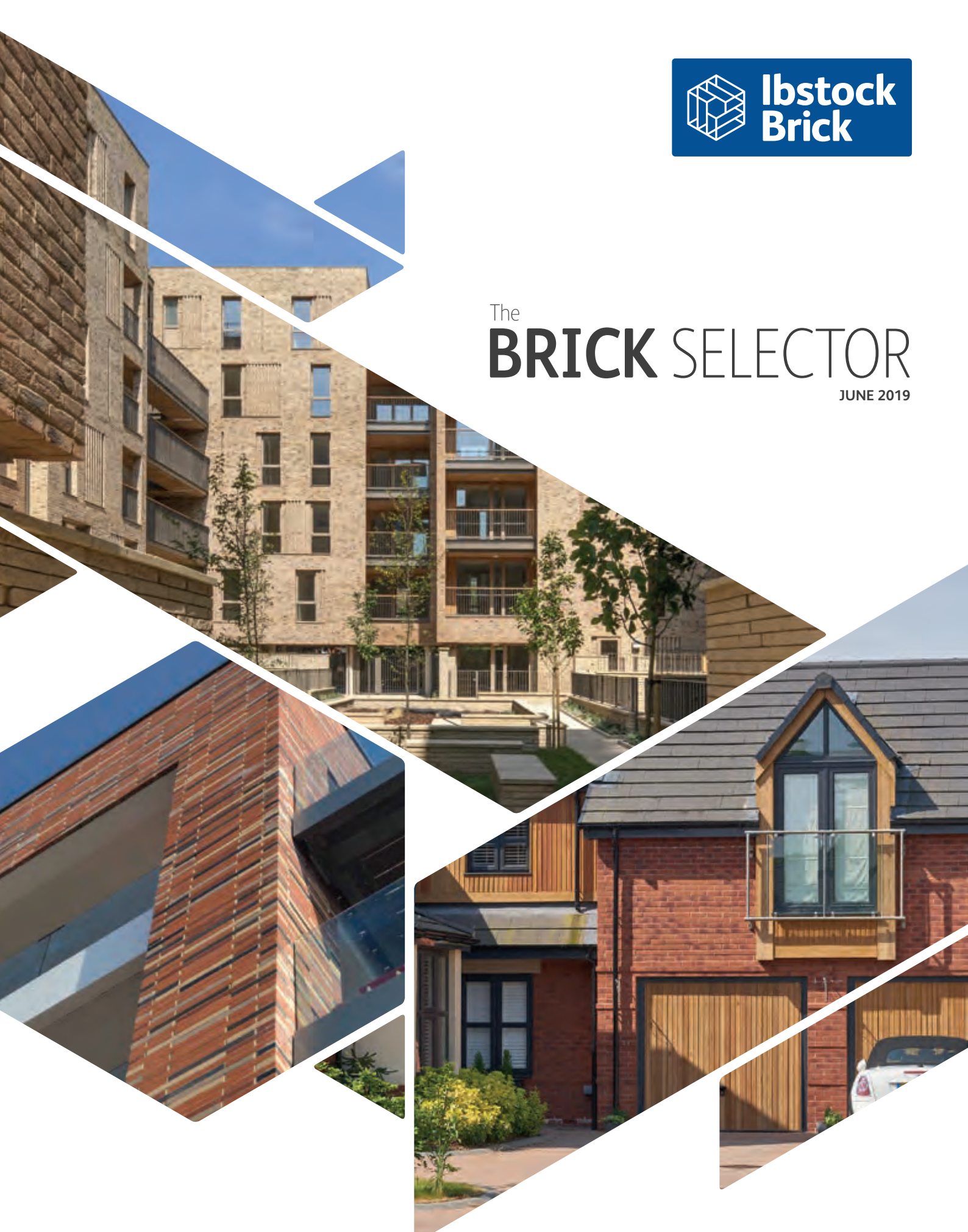

**Ibstock  
Brick**

The  
**BRICK** SELECTOR

JUNE 2019



**Ibstock**  
At the heart of building



**Ibstock**  
At the heart of building

Ibstock plc is a leading manufacturer of clay bricks and concrete products in the UK. Our vision is enabling the construction of homes and spaces that inspire people to work and live better.

## LEADING MANUFACTURERS OF...

### WALLING

- FACING BRICKS
- SPECIAL BRICKS
- WALLING STONE
- ARCHITECTURAL MASONRY
- FAÇADE SYSTEMS
- LINTELS, SILLS, ARCHES & PADSTONES
- RETAINING WALLS
- SOFFITS

### ROOFING

- ROOF TILES
- ROOF WINDOW SYSTEMS
- ROOFING ACCESSORIES
- CHIMNEYS

### RAIL & INFRASTRUCTURE

- TROUGHING
- CABLE THEFT PROTECTION
- BOARDS, BLOCKS & BASES
- CATCHPITS
- INSPECTION CHAMBERS
- RETAINING WALLS

### GARDEN & LANDSCAPING

- FENCING
- CAPS & COPINGS
- BOLLARDS
- BALLUSTRADES
- PATH EDGING
- URBAN LANDSCAPING

### FLOORING & GROUNDWORK

- FLOOR BEAMS
- DOOR STEPS
- GULLY SURROUNDS
- SCREED RAILS

### BESPOKE SERVICES

- ENGRAVING, CUTTING & BONDING
- FLOOR BEAM DESIGN & SUPPLY SOLUTIONS
- BESPOKE CONCRETE PRODUCTS

...& MUCH MORE









# WELCOME TO ISSUE 15 OF YOUR IBSTOCK BRICK SELECTOR

The **Ibstock Brick Selector** is your **comprehensive guide** to the **UK's largest brick range**

For this issue we have kept all of the **best bits** that we know **really work, including:**

- Close up shots of each of our bricks to demonstrate the texture of the product
- Now including Specials Shapes - how these products can be used to get those detailed bits of brickwork perfect
- A NEW GUIDE to brick matching, helping you to choose the correct product for your project
- Our handy Get it Right section, with helpful reminders about how to get those most important tasks right

Just visit [www.ibstockbrick.co.uk](http://www.ibstockbrick.co.uk) or call the Sample & Literature Hotline on **0844 800 4578** to request one and we will send it straight to you.



## CONTENTS

INTRODUCTION TO IBSTOCK PLC	2-3	GREY WIRECUTS, WATERSTRUCKS, STOCKS & HANDMADES	60-63
CONTENTS & SELECTING THE RIGHT BRICK FOR YOU	4-5	BLACK WIRECUTS	64-65
HOW TO CHOOSE THE RIGHT BRICK FOR YOU	6-7	BLUE WIRECUTS	66-69
COMMONLY USED JOINT PROFILES	8	LINEAR RANGE	70-73
BRICKWORK BONDING PATTERNS	9	STOCK BRICK PAVERS	74-75
GOOD PRACTICE & SAFE STORAGE FOR YOUR BRICKS	10-11	BLENDED BRICKS	76-79
RED WIRECUTS, WATERSTRUCKS, STOCKS & HANDMADES	12-19	TRADESMAN RANGE	80-81
RED MULTI WIRECUTS, WATERSTRUCKS, STOCKS & HANDMADES	20-43	SPECIAL SHAPES	82-89
BUFF WIRECUTS, WATERSTRUCKS, STOCKS & HANDMADES	44-51	IBSTOCK KEVINGTON PRODUCTS	90-93
BUFF MULTI WIRECUTS, WATERSTRUCKS & STOCKS	52-55	FACTORY INDEX	94-97
BROWN WIRECUTS, WATERSTRUCKS & STOCKS	56-59	INDEX & TECHNICAL DATA	98-103

## SELECTING THE RIGHT BRICK FOR YOU

If you're looking for a specific texture, type and colour of brick then use the table below to find the correct page right away.

BRICK TYPE	BRICK TEXTURE	BRICK COLOUR							
		RED 13-19	RED MULTI 21-43	BUFF 45-51	BUFF MULTI 53-55	BROWN 57-59	GREY 61-63	BLACK 65	BLUE 67-68
WIRECUT	SMOOTH	13	21-22	45	-	57	61	65	67-68
	SANDCREASED	-	-	-	-	57	-	-	-
	DRAGFACED	13-14	22-25	45-46	53	57	61	65	68
	RUSTICATED	14-15	25-26	46	53	57-58	61	-	-
	SANDFACED	15-16	26-27	-	53	58	61	65	-
	ROLLED	16-17	27-33	46-48	53-54	58	61	-	-
	RUMBLED	-	34	-	-	-	-	-	-
WATERSTRUCK	RUMBLED	-	34	-	-	-	-	-	-
	DISTRESSED	17	34-35	48	54	59	62	-	-
STOCK	SANDCREASED	17	36-37	48-49	54-55	-	62	-	-
	SANDFACED	17-18	37-43	49-51	55	59	62	-	-
	DISTRESSED	-	43	-	-	-	62	-	-
HANDMADE	SANDCREASED	19	43	51	-	-	63	-	-



# HOW TO CHOOSE THE RIGHT BRICK FOR YOU

We have arranged our bricks throughout this brick selector in order of colour, type of manufacture and texture. Where bricks are available in different sizes we have indicated this by a simple table. Whilst the colour of a brick is easy to see, look closely at the brick you are matching to establish the type and texture.

## COLOURS

There are **eight basic body colours** to choose from. We then add variations of darker and lighter shades to create a wider choice. N.B. bricks are made from natural materials so colours will vary slightly from batch to batch.



RED



RED MULTI



BUFF



BUFF MULTI

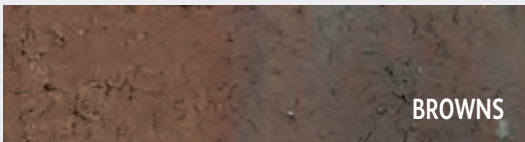

BROWNS

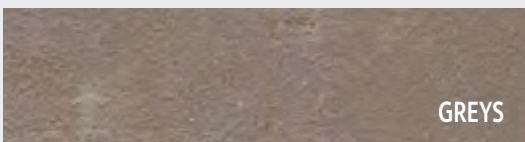

GREYS

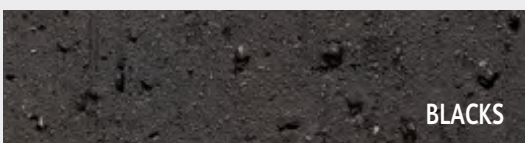

BLACKS



BLUES

## BRICK TYPES



WIRECUT

Defined edges are formed within the manufacturing process although a softer edge can be achieved by rumbling. Perforations through the body of the brick are an easy way of identifying if the brick is a wirecut. They can also be a solid brick.



WATERSTRUCK

Often a solid brick, although a few products are made frogged. Commonly a lip is evident at the bottom of the face.



## SIZES



Bricks are made in a number of sizes, the **standard being 215mm x 102mm x 65mm**. Matching the height to existing brickwork creates a more continuous appearance. A selection of products are also available in **50mm, 68mm and 73mm**. We have indicated which of our bricks come in alternative sizes throughout the brochure using the symbols shown above.

## TEXTURES

Bricks are available in several textures. Identifying the texture of the brickwork you are matching to will help to narrow down your choices.



Commonly has soft edges, always a frogged body. (Indent in the top of the brick).



Commonly has soft edges, often a frogged body. (Indent in the top of the brick).



# COMMONLY USED JOINT PROFILES

One of the factors that influence the long term performance of brickwork is the correct mortar joint profile for efficient shedding of rainwater.

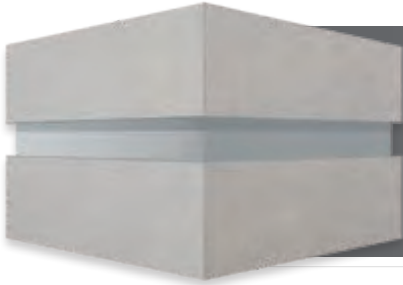

This can produce interesting shadow forming joints, but weather resistance and strength will be less than with other joints. Use only with frost resistant bricks in sheltered exposure conditions. The recess should not exceed 3-4mm and is not recommended with full fill cavity insulation.

## SQUARE RECESSED



This joint gives an improved appearance over a flush joint, with little reduction in its strength. The tooling of the mortar joint pushes it against the bricks compressing the surface of the mortar minimising any potential small air pockets, makes the surface of the mortar denser and more able to resist the ingress of wind driven rainwater. Subsequently this profile is suitable for all exposure zones.

## BUCKET HANDLE



This produces a contrasting effect of light and shade on the brickwork. Such joints, when correctly formed, have excellent strength and weather resistance and are suitable for all grades of exposure.

## WEATHER STRUCK



This gives maximum bearing area and is often favoured when coarse textured bricks are used. With some brick types the finish may appear a little irregular. Suitable for moderate and sheltered exposures as the mortar joint has not been compressed by finishing tool.

## FLUSH



## MORTAR COLOURS

Consideration should be given to mortar colour, as this will influence the appearance of the completed brickwork.

The mortar colour will help new brickwork blend in to existing brickwork, as the colour of the bricks can appear to change depending upon mortar colour.

The bricks shown left are all the same colour, only the mortar colour is different. Check out the Ibstock mortar selector at [www.ibstockbrick.co.uk](http://www.ibstockbrick.co.uk)



# BRICKWORK BONDING PATTERNS

Bonding in brickwork refers to the pattern in which they are laid. They usually overlap between courses in order to distribute load and provide stability. Bonding can also be used for decorative purposes.

**STRETCHER BOND**



**ENGLISH BOND**



**HEADER BOND**



**FLEMISH BOND**



**FLEMISH GARDEN WALL**



**ENGLISH GARDEN WALL**

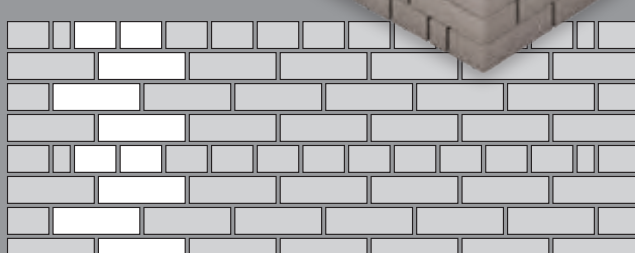
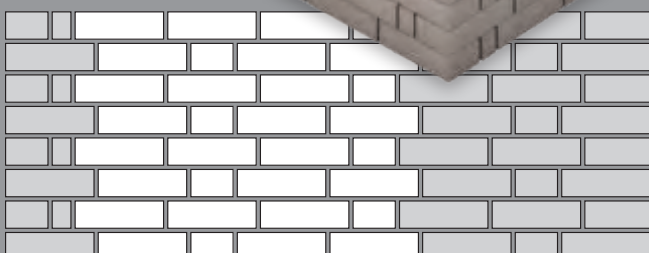
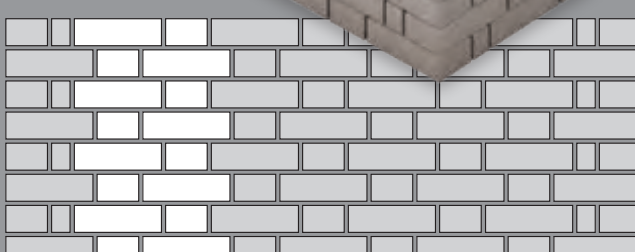
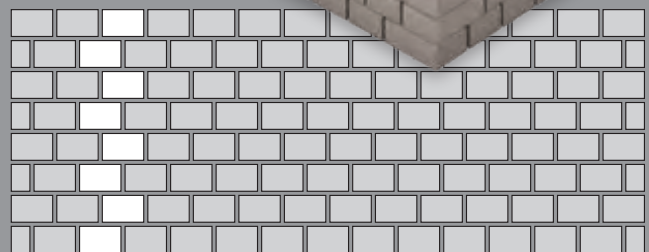
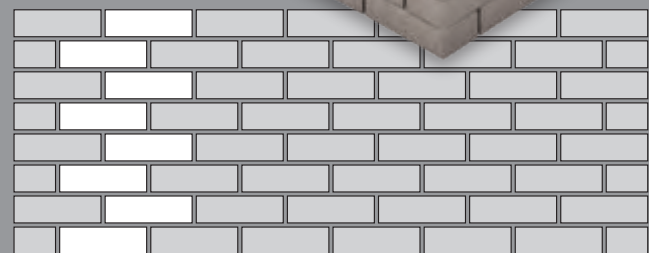



# GOOD PRACTICE & SAFE STORAGE FOR YOUR IBSTOCK BRICKS

The essential guide to good site practices with hints on what to avoid to help you create that great finish.

## BRICK STORAGE AND PROTECTION

Bricks should be inspected on delivery. They should be unloaded directly onto a hard standing that is:

- Firm
- Level
- Well drained
- Puddle free



**ALWAYS COVER OPEN PACKS**

## MIXING BRICKS

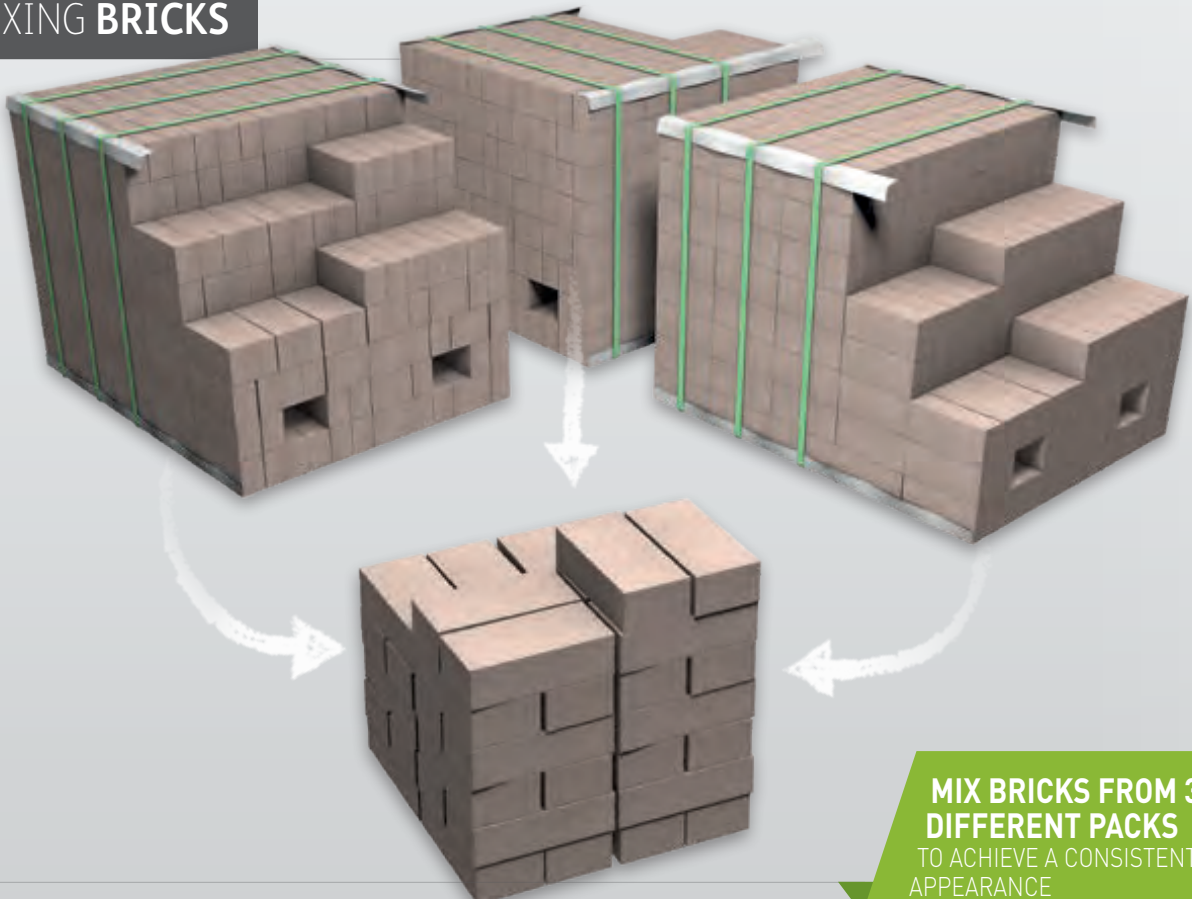

**MIX BRICKS FROM 3 DIFFERENT PACKS**  
TO ACHIEVE A CONSISTENT APPEARANCE

## PROTECTION OF NEWLY BUILT BRICKWORK

All walls must be covered when work stops. Rain on new work can cause:

- Colour change of mortar
- Lime stains
- Saturation
- Efflorescence

### REMEMBER

- Cover your brickwork!
- In rain, snow and frost use a water resistant cover
- In dry weather, use hessian or a similar product

**ALWAYS COVER BRICKWORK  
WHEN WORK STOPS**

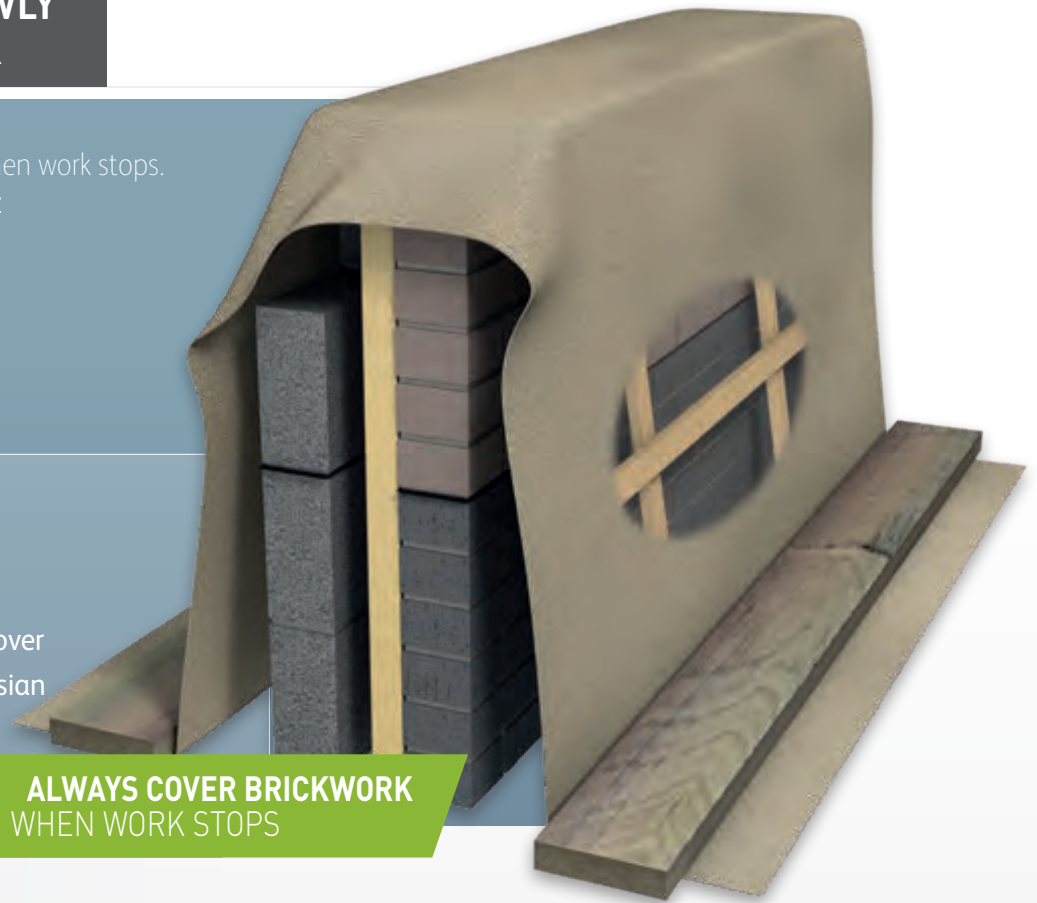

## DESIGN ADVICE

Our design & technical teams offer advice on the performance and properties of all products within the Brick Selector including British Standards and Codes of Practice.

Our team of Design Advisors can offer creative and cost-effective solutions to any design project.

Quality assured to ISO 9001, they can offer practical advice on a diverse range of issues including movement joints, brick and mortar specification through to architectural details involving special shapes.

**FOR MORE INFORMATION & ADVICE  
DOWNLOAD DATASHEETS FROM  
[WWW.IBSTOCKBRICK.CO.UK/LITERATURE](http://WWW.IBSTOCKBRICK.CO.UK/LITERATURE)**

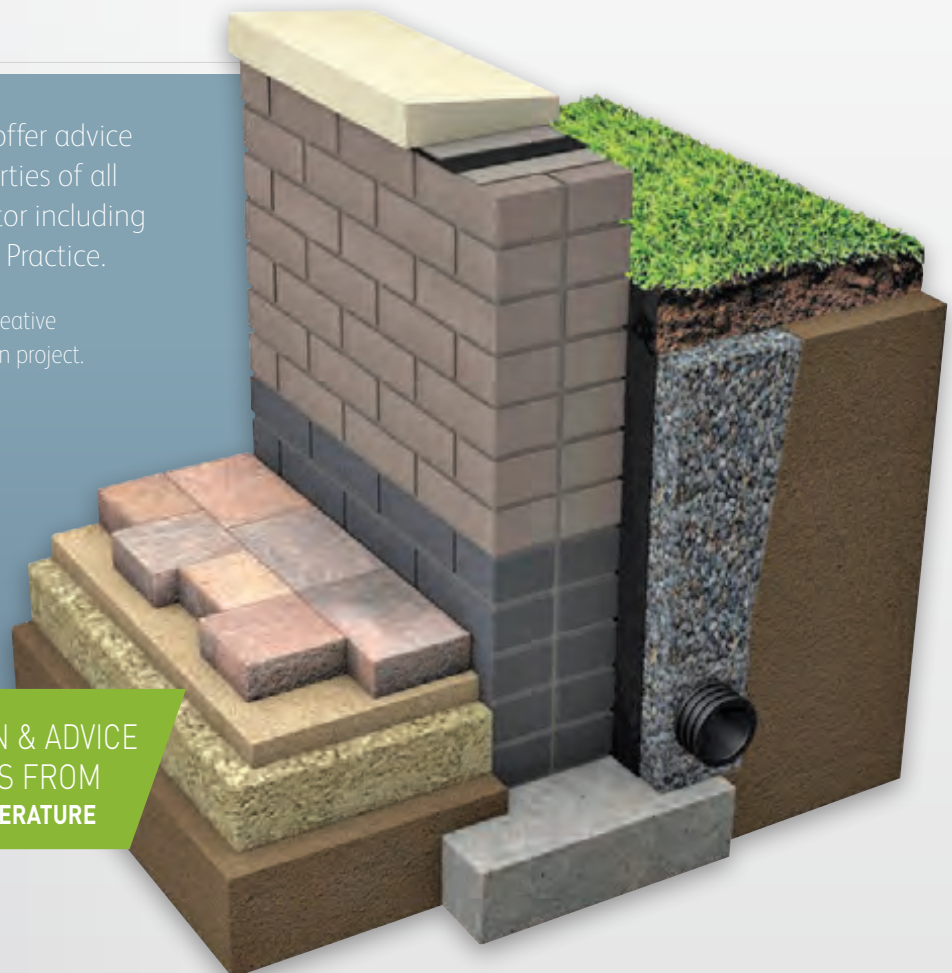



**RED** BRICKS

FROM TOP TO BOTTOM:  
Kingston Handmade Restoration Red Imperial 4354, Hadrian Red 2709,  
Anglian Red Rustic 0352 & Bristol Red 0630





Aldridge Smooth Red ●



Cheddar Red



Chester Urban Blend

Atlas 0376

Cattybrook 0610

Aldridge 0273



KINGS ROAD ARCHES, BRIGHTON  
CHEDDAR RED 0610

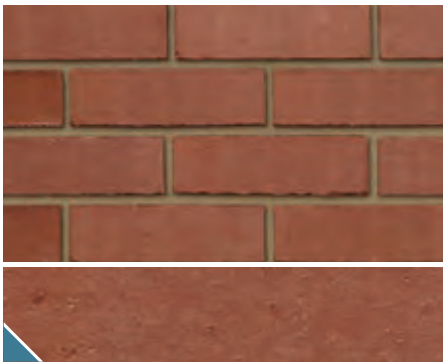

Deva Red

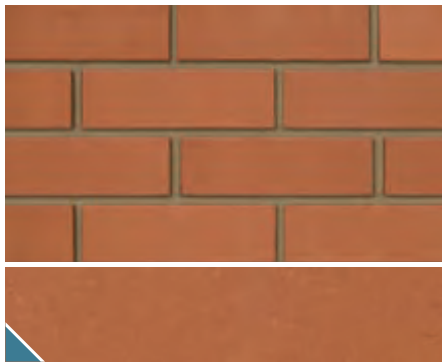

Ravenhead Red Smooth ●

Ravenhead 3501

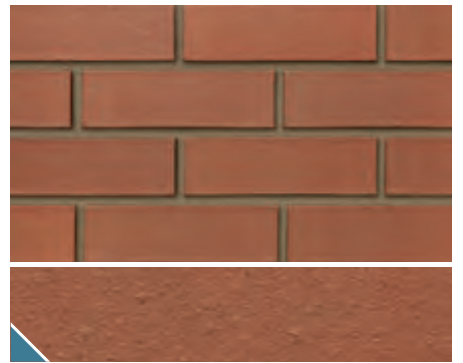

Atlas Smooth Red ●

Atlas 0300

Nostell 0526



Throckley Smooth Red



Bristol Red

Cattybrook 0630



Hollington Blend

Chesterton 2916

Throckley 2730

SMOOTH DRAGFACED ● ALSO AVAILABLE IN 73MM



MAIN SHOT & INSET: HOUSING, MOTHERWELL  
THROCKLEY RED RUSTIC 2702, ATLAS SMOOTH BLUE 2232  
& MULTI GREY RUSTIC 0268



Mixed Red Textured Throckley 2703



Ravenhead Red Rustic ● Ravenhead 3502

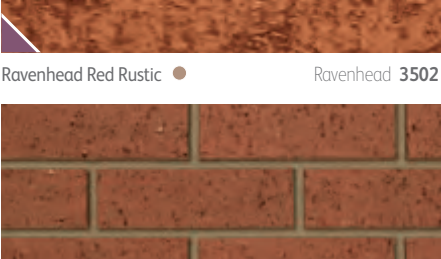

Stratford Red Dragface Atlas 0334

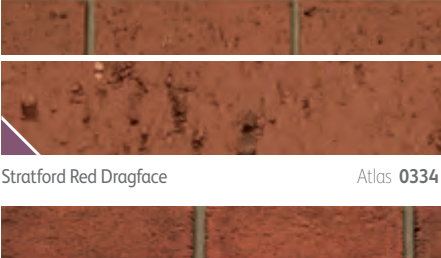

Anglian Red Rustic ● Aldridge 0352



Colonsay Red Rustic Chesterton 2964



Manorial Red Chesterton 2902



Stratford Red Rustic Atlas 0333



Atlas Smooth Blue 2232



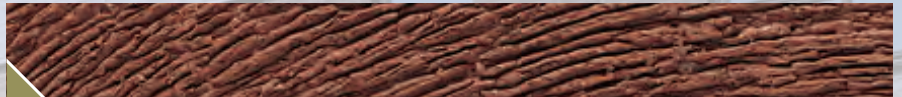

Throckley Red Rustic

Throckley 2702



Tyne Red Bark

Throckley 2701



Aston Red Sandfaced ●

Atlas 0378



Dorking Red

South Holmwood 4125





Holmwood Natural

South Holmwood 4157

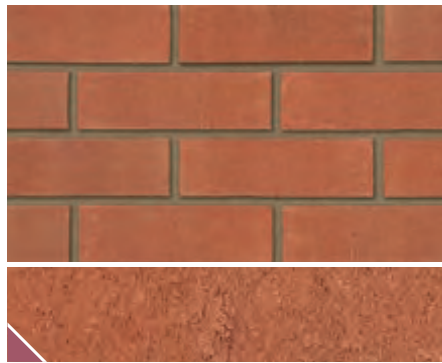

Alderley Orange

Chesterton 2946



Brunswick Red

Cattybrook 0637



Grampian Red

Chesterton 2965



Hadrian Red

Throckley 2709



Surrey Orange

South Holmwood 4131



NURSING HOME, LONDON, SE3  
HERITAGE RED BLEND 4986



Tradesman® Windsor Regent

Atlas 0395



Arden Red

Ellistown 4980



Bradgate Red

Leicester 0020



Berkshire Orange Stock

Laybrook 0771



Dorset Red Stock

Ellistown 4932



Heritage County Blend

Ellistown 4989



PRIVATE HOUSING, TELFORD  
BRUNSWICK RED 0637



Heritage Red Blend

Ellistown 4986



Laybrook Imperial Red Stock 68mm

Laybrook 0756



Leicester Orange Stock

Ellistown 4946

ROLLED SANDCREASED DISTRESSED SANDFACED





Leicester Red Stock

Eclipse 0802



Mellow Regent Stock



Parkhouse 3010

Swanage Imperial Light Stock 68mm

Swanage 4317



Swanage Imperial Red Stock 68mm

Swanage 4316





MAIN SHOT & INSETS: SMALL HOUSING REFURBISHMENT, BUXMEAD, LONDON  
 KINGSTON HANDMADE RESTORATION RED 65MM/68MM PLUS SPECIALS 4354



Swavage Handmade Heather Red ▲ Swanage 4301



Swavage Handmade Light Red ▲ Swanage 4302



Swavage Handmade Restoration Red ▲ Swanage 4312



Kingston Handmade Heather Red Imperial ● Swanage 4355



Kingston Handmade Restoration Red Imperial ● Swanage 4354



Kingston Handmade Light Red Imperial ● Swanage 4357



# RED MULTI BRICKS

FROM TOP TO BOTTOM:  
Bexhill Purple Multi 4033, Cheshire Weathered 3541,  
Tradesman® Claygate Red Multi 0329 & Tradesman® Light Rustic Blend 3542





Callerton Weathered Red 73mm



Throckley 2764

Cheshire Weathered



Ravenhead 3541

Chester Red Blend

Ravenhead 3596



Multi Red Smooth



Chesterton 2934

Pre war common 73mm



Ravenhead 3594

Priory Red

Nostell 0584





Priority Red Multi

Nostell 0589



Priority Weathered Red

Nostell 0585



Ruskin Red 73mm

Aldridge 0256



Staffordshire Smooth

Aldridge 0288



Tradesman® Common

Ravenhead 3598



Bristol Mixed Red

Cattybrook 0655



Bristol Orange Blend

Cattybrook 0656



Calderstone Claret

Ravenhead 3577





Calderstone Russett



Etruria Mixture



Hanchurch Mixture

Ravenhead 3578

Chesterton 2905

Chesterton 2922



MAIN SHOT & INSETS: STEPPING STONES SCHOOL, HINDHEAD, SURREY  
CHESTER RED BLEND 3596



Hearted Red Rustic



Himley Mixed Russet Original



Kilreggan Multi Wirecut

Ravenhead 3516

Atlas 0335

Throckley 2767





Madeley Mixture ●

Aldridge 0350



Throckley Old English

Throckley 2724



Oldcott Rustic

Ravenhead 3532

DRAGFACED ● ALSO AVAILABLE IN 73MM





Roughdales Red Multi Rustic Ravenhead 3579



Westbrick Red Purple Multi Cattybrook 0662



Wylam Olde Blend Throckley 2800



Anglian Red Multi Rustic ● Aldridge 0257



Anglian Ruskin Multi 73mm Aldridge 0356



Brunswick Multi Orange Cattybrook 0652



Cavendish Dorket Fireglow Dorket Head 2431



Georgian Red Blend Aldridge 0266



Manorial Mixture Chesterton 2933



Melton Antique Blend Nostell 0578



Melton Blend Nostell 0573





Aldridge Multi Rustic ● Aldridge 0270



New Burntwood Red Rustic ● Aldridge 0269



Shireoak Russet Aldridge 0085



Staffordshire Georgian Aldridge 0287



Staffordshire Multi Rustic ● Aldridge 0289



Balmoral Dorket Head 2405



MAIN SHOT & INSET: HOUSING, COPPICE GREEN, TELFORD  
BALMORAL 2405



Dorking Multi South Holmwood 4102



Reigate Medium Multi South Holmwood 4145



Reigate Purple South Holmwood 4148





Tradesman® Sandfaced Red Multi

Atlas 0384



Windsor

Dorset Head 2407



Alderley Burgundy

Chesterton 2947



Alderley Cottage Blend

Chesterton 2977





Alderley Mixture

Chesterton 2948



Alderley Russet Blend

Chesterton 2978



Alnwick Blend

Throckley 2801



Brunswick Antique Red

Cattybrook 0635



MAIN SHOT & INSETS: PRIVATE HOUSING, BARROW GURNEY, BRISTOL  
 BRIDGEWATER WEATHERED RED 0661, BRUNSWICK FARMHOUSE  
 MIXTURE 0636, STAFFS SLATE BLUE SMOOTH 2232



Brunswick Farmhouse Mixture Cattybrook 0636



Bridgewater Weathered Red Cattybrook 0661



Chillingham Blend Throckley 2802



Grainger Antique Throckley 2769



Grainger Autumn Throckley 2770





Grampian Red Mixture



Lenton Dark Multi



Oakham Blend

Chesterton 2967

Dorket Head 2435

Dorket Head 2478



Sherwood Blaze



Welbeck Autumn Antique



Welbeck Red Mixture

Dorket Head 2417

Dorket Head 2426

Dorket Head 2423





Welbeck Village Blend



Himley Worcestershire Mixture



Mercia Antique

Dorket Head 2413

Atlas 0317

Chesterton 2919

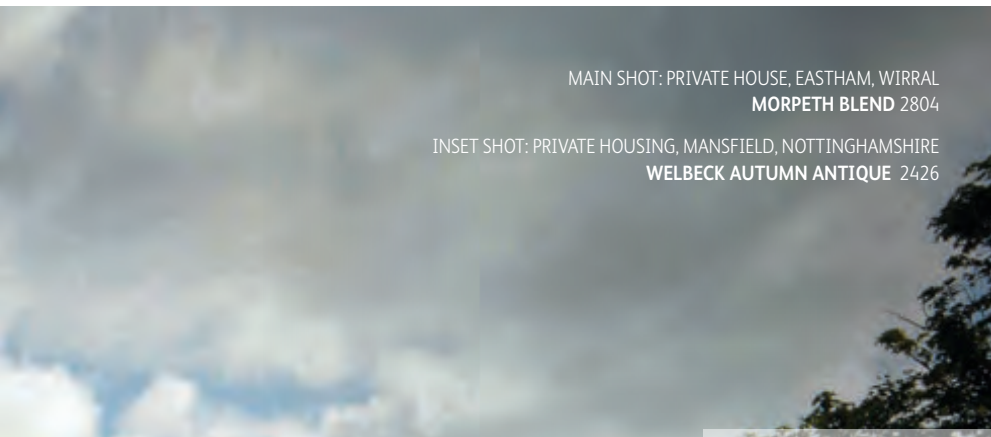

MAIN SHOT: PRIVATE HOUSE, EASTHAM, WIRRAL  
MORPETH BLEND 2804

INSET SHOT: PRIVATE HOUSING, MANSFIELD, NOTTINGHAMSHIRE  
WELBECK AUTUMN ANTIQUE 2426



Mercia Orange

Chesterton 2974



Mercia Orange Multi



Morpeth Blend



Oakleigh Red Blend

Chesterton 2976

Throckley 2804

Ravenhead 3527





Ormonde Antique Blend



Ravenhead 3518

Severn Multi Red Blend



Surrey County Red

South Holmwood 4132

Cattybrook 0647



MAIN SHOT AND INSET:  
PRIVATE HOUSING, KIDBROOKE VILLAGE, LONDON SE3  
SURREY LIGHT MULTI 4143



Surrey Red Multi

South Holmwood 4133



Tradesman® Antique Rustic Blend ●

Atlas 0389





Surrey Russet

South Holmwood 4136



Surrey Light Multi

South Holmwood 4143



Tradesman® Cheviot

Atlas 0385



Tradesman® Claygate Red Multi

Atlas 0329



Tradesman® Light Rustic Blend

Ravenhead 3542



Tradesman® Rustic Blend ●

Atlas 0383



Tradesman® Tudor Regent

Atlas 0323



Worsley Weathered

Ravenhead 3509

▲ ROLLED ● ALSO AVAILABLE IN 73MM





Cheshire Weathered



Ravenhead 3541

Worsley Weathered



Northumbrian Cottage

Birtley 2622

Ravenhead 3509



PRIVATE HOUSE, ULLENHALL, WARWICKSHIRE  
OTTERBURN ANTIQUE 2621



Arden Weathered Red

Ellistown 4982



Beamish Blend ●

Birtley 2601



Birtley Olde English ●

Birtley 2602



Borrowdale Blend

Birtley 2631



Commercial Red ●

Birtley 2611



Cumberland Blend

Birtley 2629





LEFT SHOT AND INSET:  
SIX PINS AND HALF A DOZEN NEEDLES, LONDON  
BIRTLEY OLDE ENGLISH 2602



Northumbrian Cottage Birtley 2622



Otterburn Antique Birtley 2621



Warwickshire Olde English ● Birtley 2613



Townhouse Blend Birtley 2623

▲ DISTRESSED ● ALSO AVAILABLE IN 73MM





Bradgate Claret

Leicester 0031



Bradgate Regal

Leicester 0021



Grosvenor Autumn Flame

Leicester 0176



MAIN SHOT AND INSETS:  
PRIVATE HOUSING, PRESTBURY, CHESHIRE  
IVANHOE OLDE VILLAGE 0062



Grosvenor County Mixture



Ivanhoe Antique

Leicester 0149

Leicester 0060



Ivanhoe Cottage Blend

Leicester 0055



Ivanhoe Katrina Multi

Leicester 0059



Ivanhoe Mellow Red

Leicester 0058



Ivanhoe Olde Village

Leicester 0062



Audley Red Mixture Stock

Parkhouse 3022

▲ SANDCREASED ▲ SANDFACED





Betley Cottage Blend

Parkhouse 3058



Bexhill Dark

Ashdown 4009



Bexhill Purple Multi

Ashdown 4033



PRIVATE HOUSE, GOLDERS GREEN, LONDON  
BEXHILL PURPLE MULTI 4033



Bexhill Red

Ashdown 4010



Cissbury Red Multi Stock

Laybrook 0767



Dorset Multi Red Stock

Ellistown 4941



Hamsey Mixed Stock

Chailey 4517



Cottage Mixture

Ashdown 4001





Heritage Light Red Multi

Ellistown 4977



Capital Multi Stock

Laybrook 0717

PRIVATE HOUSING, WEST SUSSEX  
CAPITAL MULTI STOCK 0717



Ivanhoe Westminster

Eclipse 0825



Lambourn Orange Multi Stock

Parkhouse 3035



Leicester Autumn Multi

Ellistown 4937





Leicester Multi Red Stock Eclipse 0812



Leicester Weathered Multi Ellistown 4935



Leicester Weathered Red Eclipse 0813

PRIVATE HOUSING, BERKHAMSTED, HERTFORDSHIRE  
NEW CAVENDISH STOCK 3018



PRIVATE HOUSE, REYDON, SUFFOLK  
NEW CHAILEY RUSTIC STOCK 4514



West Hoathly Medium Multi Stock West Hoathly 0731



Mellow Ashridge Stock Parkhouse 3025





Multi Orange Stock

Laybrook 0772



New Cavendish Stock

Parkhouse 3018



New Chailey Rustic Stock

Chailey 4514



New Chailey Stock

Chailey 4501



New Sandhurst Stock

Parkhouse 3057



Parham Light Multi Stock

Laybrook 0732





Petworth Multi Stock



Pevensey Multi Stock



Rustique Blend

Laybrook 0700

Ashdown 4004

Ellistown 4947



West Hoathly Sharpthorne Mixture Stock

West Hoathly 0736



Sussex Blend

West Hoathly 0778



Thakeham Red Multi Stock

Laybrook 0709





Weston Red Multi Stock



Arden Olde Farmhouse Original



Swanage Handmade Light Red Multi ▲ Swanage 4303

Parkhouse 3055

Ellistown 4985



Kingston Handmade Light Red Multi Imperial ● Swanage 4356



Tonbridge Handmade Multi ▲



West Hoathly Handmade Multi Stock ▲ Ashdown 4046

Ashdown 4043



# BUFF BRICKS

FROM TOP TO BOTTOM:  
Southwark Yellow Stock 0165, Smooth Buff 2712,  
Argyll Buff Wirecut 0539 & Mixed Buff Rustic 2760



STUDENT ACCOMMODATION, MAYNOOTH UNIVERSITY, MAYNOOTH, CO DUBLIN  
 BIRTLEY OLDE ENGLISH BUFF 2605 & WHITE ENGOBE 5145



Cheddar Golden



Continental Buff



New Diana

Cattybrook 0611

Imported 5149

Imported 5143



Smooth Buff



White Engobe

Imported 5145

Throckley 2712



Argyll Buff Wirecut

Nostell 0539



Bristol Gold



Earlswood Textured Buff

Atlas 0100

Cattybrook 0634



Harewood Russet Buff

Nostell 0565



MAIN SHOT & INSET:  
PRIVATE HOUSING, GREAT LONDON  
BRUNSWICK WILTON YELLOW 0643  
& STAFFORDSHIRE SLATE BLUE SMOOTH 2232



Lansdown Multi Gold

Cattybrook 0627



Oatmeal Textured

Throckley 2715



Royston Golden Buff

Nostell 0517



Sandalwood

Throckley 2731



Stuart Buff

Throckley 2738



Anglian Beacon Sahara ●

Aldridge 0258



Anglian Buff Multi Rustic

Aldridge 0353



Cavendish Dorket Honeygold

Dorket Head 2434



Mixed Buff Rustic

Throckley 2760



Brunswick Autumn

Cattybrook 0638





Brunswick Buff

Cattybrook 0640



Brunswick Wilton Yellow

Cattybrook 0643



Hadrian Buff

Throckley 2708



Minster Beckstone Mixture

Dorket Head 2428



Minster Cream Blend

Dorket Head 2419



MAIN SHOT & INSET:  
 APARTMENTS, GREENWICH, LONDON  
 FUNTON OLD CHELSEA YELLOW 4053



Minster Sandstone Mixture Dorket Head 2418



Surrey Cream Multi South Holmwood 4138



Birtley Olde English Buff Birtley 2605



Northern Buff Birtley 2618



Bradgate Golden Purple Leicester 0023



Bradgate Harvest Antique Leicester 0028





Bradgate Light Buff

Leicester 0025



Bradgate Multi Cream

Leicester 0030



Arundel Yellow Multi Stock

Laybrook 0713



Coleridge Yellow Multi

Ashdown 4027



Cooksbridge Rustic Blend

Chailey 4527



Cooksbridge Yellow Clamp Stock

Chailey 4512

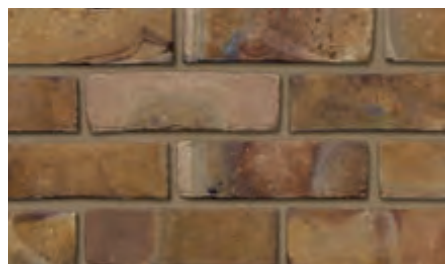

Funton Old Chelsea Yellow ◆

Ashdown 4053

▲ SANDCREASED

▲ SANDFACED

◆ ALSO AVAILABLE IN IMPERIAL (228 X 110 X 68MM) FORMAT





Funton Harvest Mixture Ashdown 4049



Funton Second Hard Stock Ashdown 4050



HOUSING, HAVERHILL, SUFFOLK  
LEICESTER MULTI CREAM MULTI 0189



Gault Cream Stock Leicester 0167



London Reclaim Mixture Ashdown 4052



Marlborough Stock Parkhouse 3016





Leicester Multi Cream Stock

Leicester 0189



Leicester Multi Yellow Stock

Leicester 0185



Sevenoaks Yellow Stock

Laybrook 0730



Southwark Multi Stock

Leicester 0166



Southwark Yellow Stock

Leicester 0165



Tonbridge Handmade Pastone ▲

Ashdown 4044



# BUFF MULTI BRICKS

FROM TOP TO BOTTOM:  
New Ivanhoe Cream 0805, Grainger Gold 2771,  
Millhouse Blend 2630 & Tradesman® Buff Multi 0304





Bristol Buff Multi

Cattybrook 0657



Caledonian Buff Blend

Atlas 0390



Trafford Multi Rustic

Ravenhead 3576



Argyll Buff Multi Rustic

Nostell 0537



Sandringham

Dorket Head 2406



Dilston Blend

Throckley 2803



Grainger Gold

Throckley 2771



Lenton Cream Multi

Dorket Head 2457



Lenton Golden Russet

Dorket Head 2458



OMAGH HOSPITAL & PRIMARY CARE COMPLEX, CO. TYRONE, N. IRELAND  
**CALEDONIAN BUFF BLEND 0390**





Surrey Yellow Multi South Holmwood 4156



Tradesman® Buff Multi Atlas 0304



Tradesman® Millgate Buff Cattybrook 0620



Millhouse Blend Birtley 2630

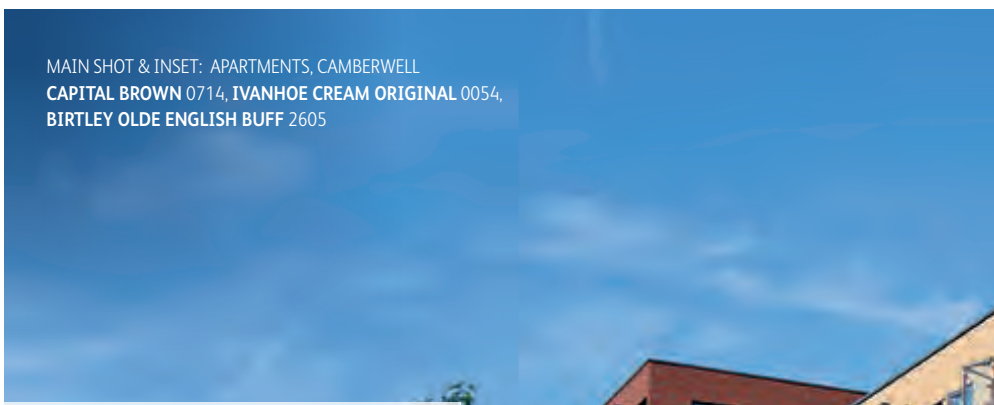

MAIN SHOT & INSET: APARTMENTS, CAMBERWELL  
CAPITAL BROWN 0714, IVANHOE CREAM ORIGINAL 0054,  
BIRTLEY OLDE ENGLISH BUFF 2605



Amato Blend Leicester 0103





Dinian Blend

Leicester 0102



Ivanhoe Cream Original

Leicester 0054



Floriana Blend

Leicester 0104



Ivanhoe Athena Blend

Leicester 0061



New Ivanhoe Cream

Eclipse 0805



**BROWN**  
BRICKS

FROM TOP TO BOTTOM:  
**Birtley Brown Waterstruck** 2634, **Holbrook Sandfaced Brown** 4119  
**Bracken Brown Rustic** Ravenhead 3505 & **Milburn Ashen Brown Blend** 2775





Cheddar Brown

Cattybrook 0612



Smooth Village Mixture

Ravenhead 3536



Bristol Brown

Cattybrook 0628



Bracken Brown Rustic

Ravenhead 3505



Brown Blend

Aldridge 0260



Etruscan

Chesterton 2912



Himley Dark Brown Rustic

Aldridge 0355



BARRATS, STONEGROVE  
CAPITAL BROWN MULTI STOCK 0714 & SURREY RED MULTI 4133





Holbrook Sandfaced Brown



South Holmwood 4119



Tradesman® Heather Mixture ●



Atlas 0381



Milburn Ashen Brown Blend



Throckley 2775







Birtley Brown Waterstruck

Birtley 2634



Capital Brown Multi Stock

Laybrook 0714

PRIVATE HOUSING, HERTFORDSHIRE  
CAPITAL BROWN MULTI STOCK 0714





**GREY** BRICKS

FROM TOP TO BOTTOM:  
Bradgate Medium Grey 0032, Tradesman® Light 0382,  
Tonbridge Handmade Heather Grey 4042 & Tradesman® Antique Grey 0314



MAIN SHOT & INSET:  
 APARTMENTS, KILMARNOCK, AYRSHIRE  
 TRADESMAN® ANTIQUE GREY 0314  
 & KILCREGGAN MULTI STOCK 2767



Dark Grey



Light Grey



Himley Ash Grey



Royston Silver Grey



Multi Grey Rustic

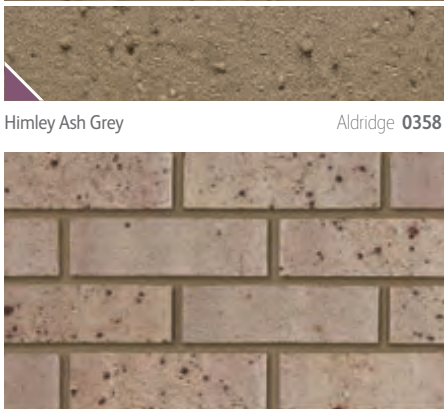

Tradesman® Light ●

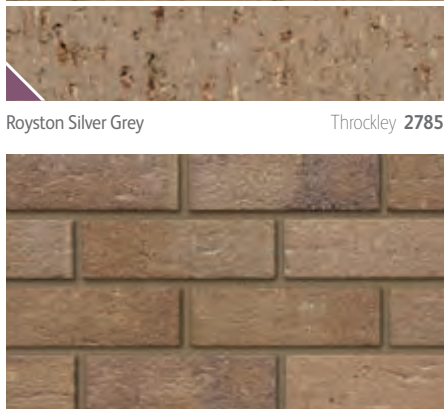

Brunswick Tryfan Grey

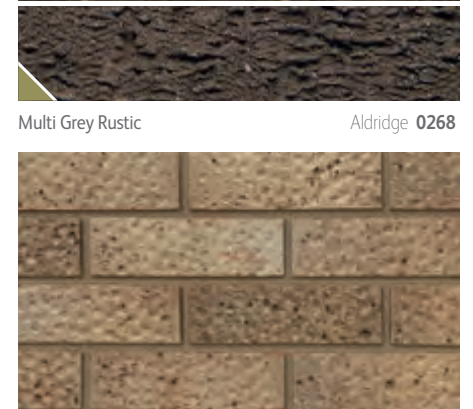

Tradesman® Antique Grey



Atlas 0382



Cattybrook 0642



Atlas 0314





Arden Grey

Ellistown 4979



Birtley Olde English Grey

Birtley 2640



Bradgate Medium Grey

Leicester 0032



Bruges Blend

Leicester 0101



Crowborough Multicoloured Stock

Ashdown 4002



Kingscote Grey Multi

West Hoathly 0750



Leicester Grey Stock

Ellistown 4978



Leicester Weathered Grey Stock

Ellistown 4933



Arden Weathered Grey

Ellistown 4990





MAIN SHOT & INSET: APARTMENTS, GOVAN, GLASGOW  
BRUNSWICK TRYFAN GREY 0642



Tonbridge Handmade Heather Grey ▲ Ashdown 4042



Tonbridge Handmade Grey Brown ▲ Ashdown 4041

■ SANDFACED    ▽ SANDCREASED    ▲ ALSO AVAILABLE IN 50MM



**BLACK**  
BRICKS

FROM TOP TO BOTTOM:  
Holbrook Sandfaced Dark 4120, Black Smooth 5144,  
Holbrook Sandfaced Black 4149 & Himley Ebony Black 0354





Black Smooth

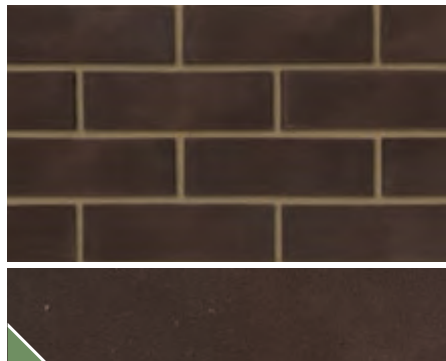

Imported 5144



Holbrook Sandfaced Black

South Holmwood 4149

Holbrook Sandfaced Dark

South Holmwood 4120



PARK VIEW PRIMARY SCHOOL, CAMBUSLANG  
KINGSCOTE GREY MULTI 0750 & HIMLEY EBONY BLACK 0354



Himley Ebony Black

Aldridge 0354



**BLUE** BRICKS

FROM TOP TO BOTTOM:  
Staffordshire Slate Blue Smooth 2232, Staffordshire Blue Brindled Smooth 2220,  
Brunel Smooth Blue Perforated 5050 & Staffordshire Blue Brindled Dragface 2221





Atlas Smooth Blue



Brunel Smooth Blue Solid

Lodge Lane 2249

Imported 5051



MAIN SHOT & INSET: APARTMENTS, LONDON  
STAFFORDSHIRE SLATE BLUE SMOOTH 2232



Brunel Smooth Blue Perforated ▼ Imported 5050



Staffordshire Slate Blue Smooth ● Lodge Lane 2232

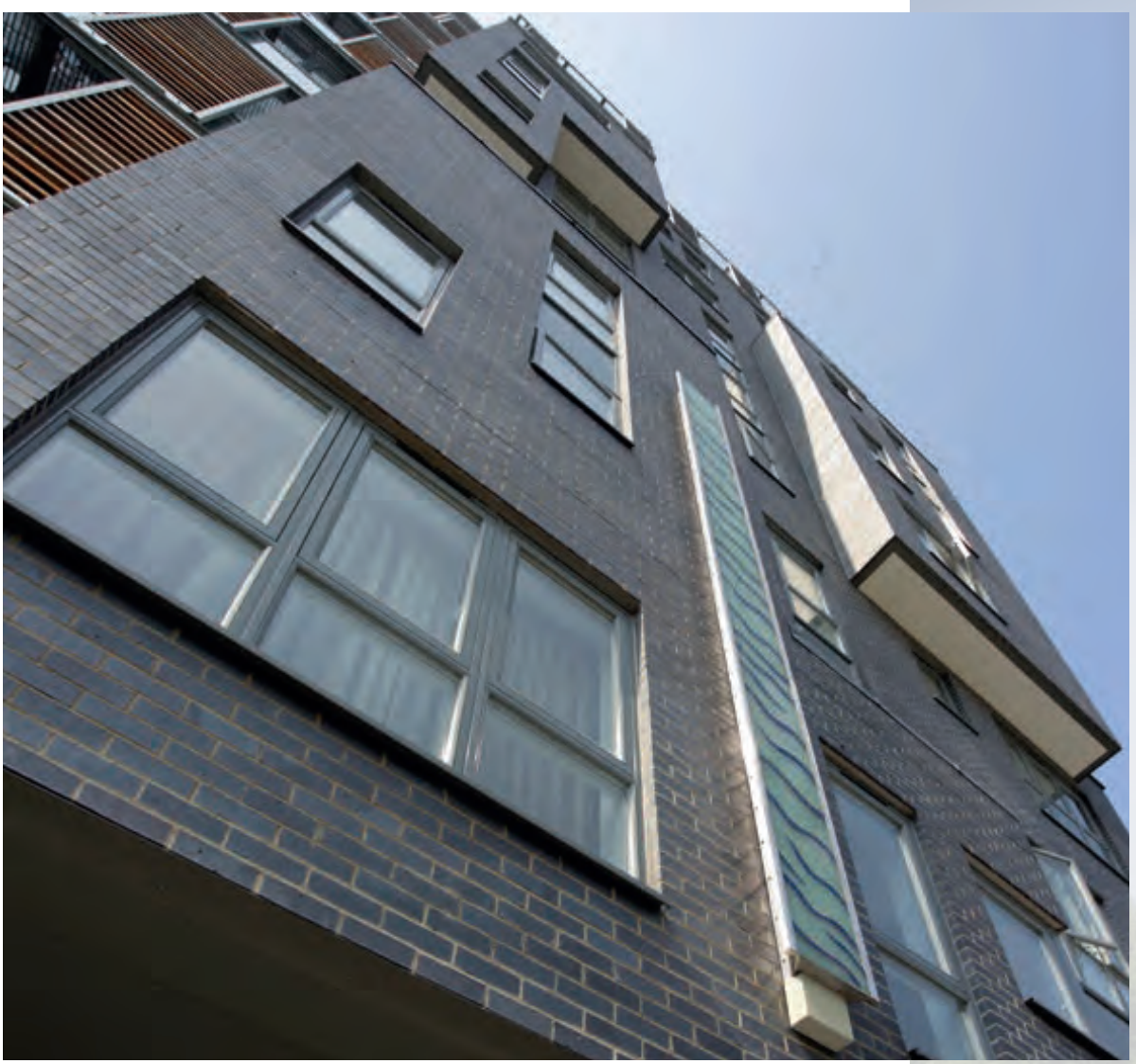

Staffordshire Blue Brindle Smooth Lodge Lane 2220



Staffordshire Blue Brindled Dragface Lodge Lane 2221









# LINEAR BRICKS



Natural Blue River



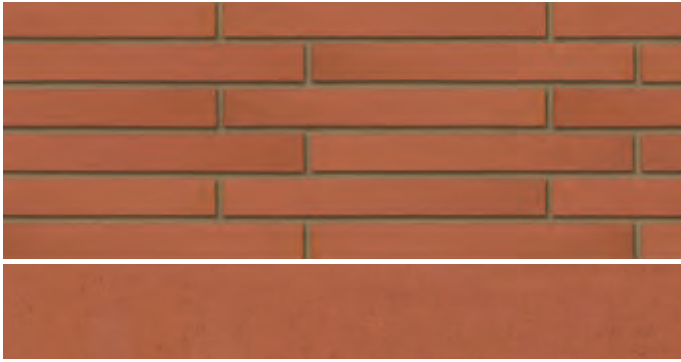

Orange



Natural Red Riven



Natural Cream Riven



Natural Grey Riven



Dark Grey Tidal



Black

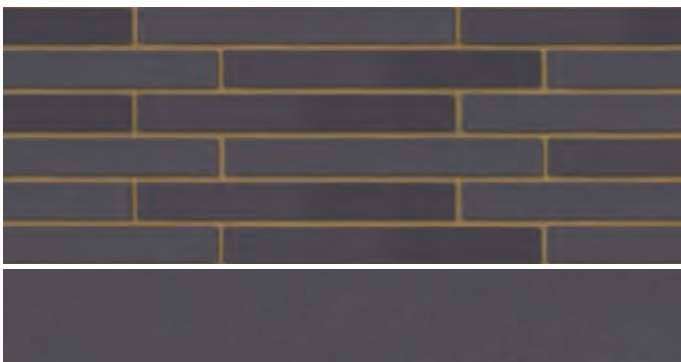

Natural Blue

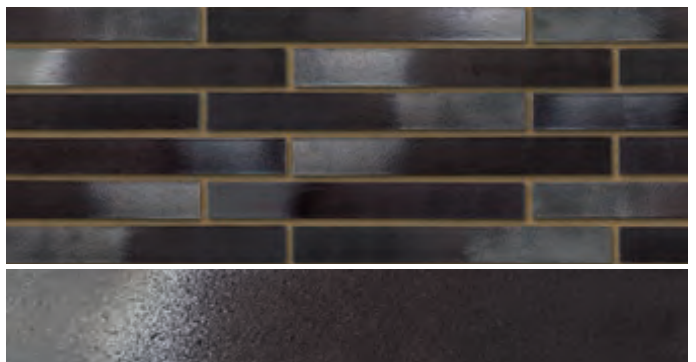

Silver Black



Black Riven

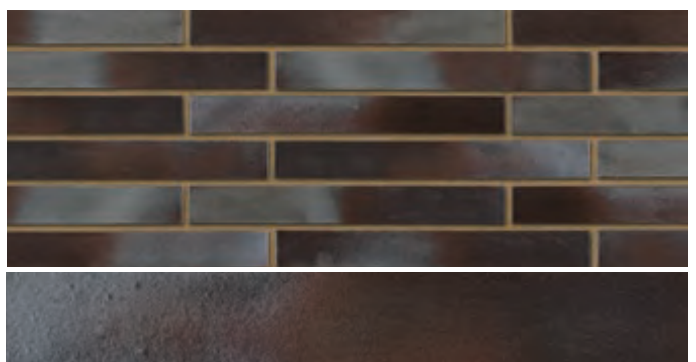

Steel Black



LAYBROOK RANGE



Parham Red Stock



Parham Light Multi Stock

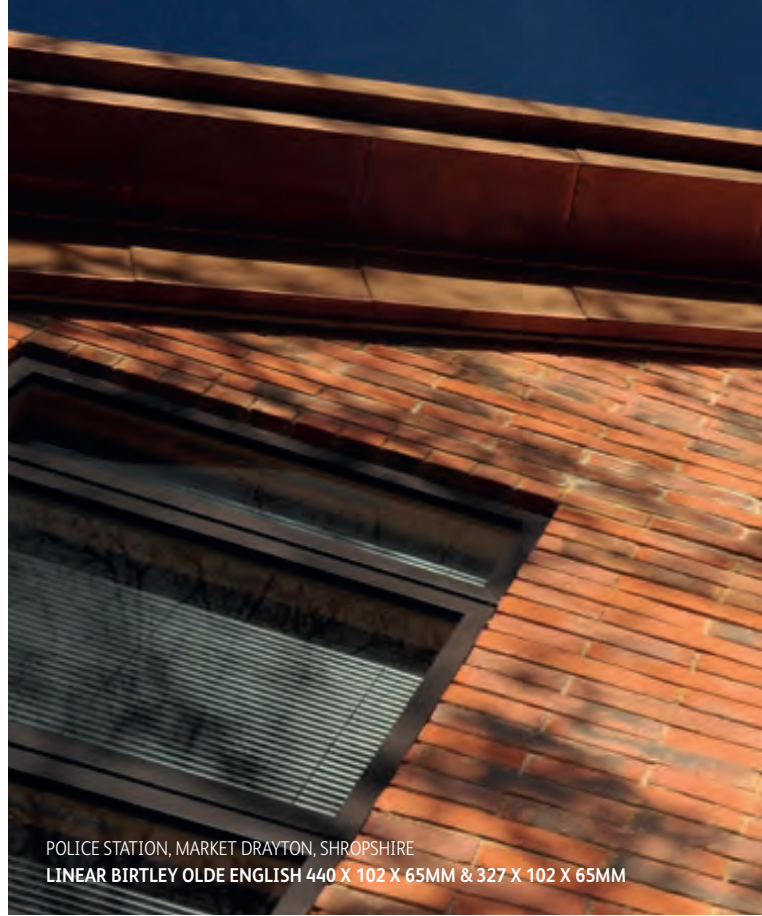

POLICE STATION, MARKET DRAYTON, SHROPSHIRE  
LINEAR BIRTLEY OLDE ENGLISH 440 X 102 X 65MM & 327 X 102 X 65MM

BIRTLEY RANGE



Beamish Blend



Birtley Olde English



Millhouse Blend



Birtley Brown Waterstruck



Birtley Olde English Buff



Linear Birtley Olde English Grey





IMPORTED RANGE



MG500-44 Dark Grey Multi



MG500-D Light Grey Multi



MG500 Light Grey



BM500 White



MR500 Red Multi



MK500 Black Multi



# STOCK BRICK PAVERS

At Ibstock Brick, we specialise in stock brick pavers. Their softer appearance and warm natural clay colours make them perfect for domestic settings, such as driveways, paths and patios.

LAYBROOK FLAME RED STOCK PAVER 0773  
PRIVATE HOUSE



CLAY PAVERS ARE  
EASY TO INSTALL

## CLAY PAVERS HAVE MANY BENEFITS OVER CONCRETE ALTERNATIVE

The colours are formed throughout the paver as a result of firing natural clays at around 1000°C. Typically, concrete pavers use surface colours and tints which often wear, fade and chip to reveal the grey aggregates and substrate beneath. In addition, the effects of water and sunlight on the surface of our clay pavers actually enhances their appearance and helps maintain a clean surface.

This is due to the ceramic nature of the surface and it is this property that ensures clay pavers have excellent resistance to staining or erosion from weak alkalis and acids such as detergents used in car washing and acid rain. Prolonged exposure can cause concrete alternatives to fade.

## CHOOSE CLAY PAVERS

They are simple to cut and have five possible decorative wear faces, unlike concrete, which has just one! This means that edges, corners, kerbs and steps can all be formed from the paver you choose without the need or cost of specially shaped units.



Laybrook Flame Red Stock Paver

Laybrook 0773

## LAYING OPTIONS

WE OFFER TWO PAVING OPTIONS;

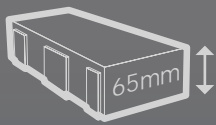

### SUSTAINABLE DRAINAGE SYSTEM (SUDS)

pavers are laid on a suitable permeable aggregate sub-base. They measure 200mm (length) x 100mm (width) x 65mm (height) including the width of the spacers.

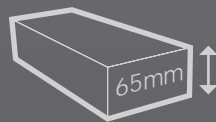

### FLEXIBLE PAVERS

are bedded on sand. These measure 200mm (length) x 100mm (width) x 65mm (height).

## FLEXIBLE PAVING



Laybrook Red Multi Stock Paver

Laybrook 0727





LAYBROOK FLAME RED STOCK PAVER SUDS MN0773A

**TOP TIP**

THE UNIQUE TAPERED PROFILE JOINTS MAKE WALKING ON OUR SUDS PAVER EASY.

## SUSTAINABLE DRAINAGE SYSTEMS (SUDS)

Since October 2008, the use of SUDS surface finishes is a legal requirement for many driveways joining the public highway. Therefore, any new surface should incorporate a water permeable layer to minimise excess run-off during heavy rain. To fit impermeable surfaces, above a certain area, requires the submission of a planning application, a fee and associated delays.



LAYBROOK FLAME RED STOCK SUDS PAVER MN0773A

**TOP TIP**

THE UNIQUE CONCEALED SPACERS ALLOW THE PAVERS TO BE LAID IN MANY DECORATIVE PATTERNS WITHOUT UNSIGHTLY GAPS.

We have introduced the only clay stock brick pavers that are **SUDS compliant** and that can also be used for water harvesting systems.

This means that you can **enjoy the lasting beauty** of clay pavers anywhere around your home.

THE PAVERS **MUST BE** BEDDED ON AN APPROPRIATE PERMEABLE PAVEMENT AGGREGATE SUB-BASE.  
**YOUR INSTALLER WILL BE ABLE TO ADVISE YOU.**



Laybrook Multi Stock SUDS Paver

Laybrook 0726



Laybrook Red Multi Stock SUDS Paver

Laybrook 0727



**BLENDED**  
BRICKS

FROM TOP TO BOTTOM:  
Millhouse Blend 2630, Beamish Blend 2601,  
Borrowdale Blend 2631 & Cumberland Blend 2629



# BLENDING IMAGINATION WITH DESIGN

With the amazing range of bricks available from Istock Brick, it is difficult to imagine there isn't a brick to match any situation. Whether it is to match up with existing brickwork or to impress your own identity upon a new project, the options are unlimited.



MILHOUSE BLEND 2630



Rustique Blend

Ellistown 4947



Cumberland Blend

Birtley 2629



Milhouse Blend

Birtley 2630



Beamish Blend ●

Birtley 2601



## SPECIALIST BLENDING FACTORIES

These 5 factories have a rich history in producing beautiful brick blends – but with another 14 manufacturing sites and more than 300 brick types in our range, the possibilities really are endless.



SWANAGE

TRADITIONAL AND BESPOKE STOCK BRICKS

Beautiful individually crafted stock bricks available in unique colours, textures and sizes. All products are complemented with a full range of handmade special shapes.



BIRTLEY

MAKING BEAUTIFUL BRICKS FOR OVER A CENTURY

Authentic waterstruck bricks manufactured for over 100 years. Birtley couples traditional production with the latest firing technology creating an extensive and varied range of colours.



BEAMISH BLEND 2601  
PRIVATE HOUSING, LEICESTERSHIRE



Borrowdale Blend ●



Birtley 2631 Townhouse Blend



Birtley 2623

See pages 104-107 for details of our products by factory, including the geographical location of each factory. Choosing bricks from local factories reduces delivery costs and is better for the environment.

● also available in 73mm





LEICESTER

THE HOME OF BEAUTIFUL STOCK BRICKS

The largest range of standard and crease-textured stock bricks of any factory in the UK, making Leicester your first choice for stock bricks.



CHAILEY

300 YEARS OF BRICK-MAKING HISTORY

Fired in a traditional clamp to give the distinctive warm Chailey colours. Clamp-fired stock bricks are differentiated from modern clay bricks in terms of colour and texture.



WEST HOATHLY

CLAMP-FIRED STOCK BRICKS

One of the last traditional Clamp-fired stock brick factories producing unique colours, hand-sorted for consistency.



Bruges Blend



Dinian Blend

Leicester 0101

Leicester 0102



Amato Blend Leicester 0103



Floriana Blend

Leicester 0104



FOR OUR **EASY-TO-USE ONLINE BRICKBLENDING TOOL** VISIT  
[WWW.IBSTOCKBRICK.CO.UK/BRICK-BLENDER](http://WWW.IBSTOCKBRICK.CO.UK/BRICK-BLENDER)



# TRADESMAN<sup>®</sup> RANGE

IBSTOCK<sup>®</sup> TRADESMAN<sup>®</sup>

*More than a match for the originals*

From the 1930s onwards many houses were built using bricks made from distinctive lower Oxfordshire clays. Our Tradesman<sup>®</sup> range has been meticulously designed to blend in with these bricks wherever they are used.

Tradesman's superior durability and strength means they are ideal for use in most locations, such as boundary walls and wall cappings or to match existing brickwork for extensions and other refurbishments.

They are also popular with builders because of their excellent colour consistency and are also easy to lay with minimal wastage.



Tradesman<sup>®</sup> Heather Mixture ●

Atlas 0381



**IDEAL FOR**  
EXTENSIONS, GARDEN WALLS &  
REFURBISHMENT PROJECTS



Tradesman<sup>®</sup> Antique Rustic Blend ●

Atlas 0389



Tradesman<sup>®</sup> Cheviot

Atlas 0385



Tradesman<sup>®</sup> Claygate Red Multi

Atlas 0329



Tradesman<sup>®</sup> Common

Ravenhead 3598



Tradesman<sup>®</sup> Light Rustic Blend

Ravenhead 3542



Tradesman<sup>®</sup> Sandfaced Red Multi

Atlas 0384



TRADESMAN® ANTIQUE GREY 0314  
APARTMENTS, KILMARNOCK, Ayrshire



Tradesman® Rustic Blend ●

Atlas 0383



Tradesman® Tudor Regent

Atlas 0323



Tradesman® Windsor Regent

Atlas 0395



Tradesman® Buff Multi

Atlas 0304



Tradesman® Millgate Buff



Tradesman® Antique Grey

Atlas 0314

Cattybrook 0620



Tradesman® Light ●

Atlas 0382



See pages 104-107 for details of our products by factory, including the geographical location of each factory.  
Choosing bricks from local factories reduces delivery costs and is better for the environment.



# SPECIAL SHAPES

BRICKS







everyday  
SPECIALS

## EVERYDAY SPECIAL SHAPED BRICKS

We view special shapes and fittings as those simple design elements that make good brickwork a masterpiece.

The Everyday Range includes all the most popular special shapes and fittings now readily available. To help you further we have a dedicated team of experienced sales co-ordinators.

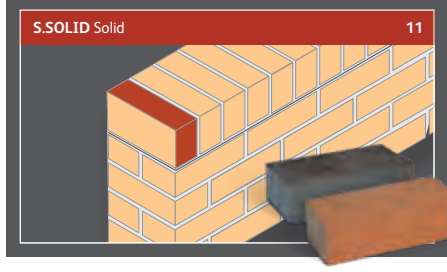
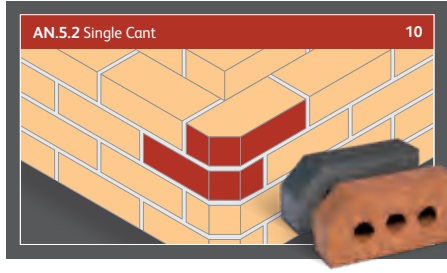
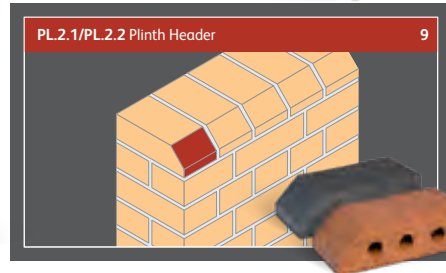
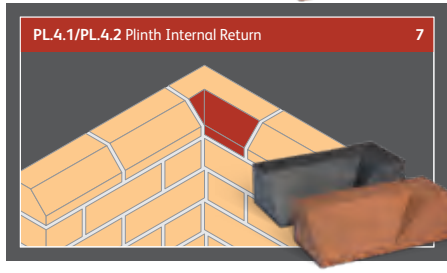
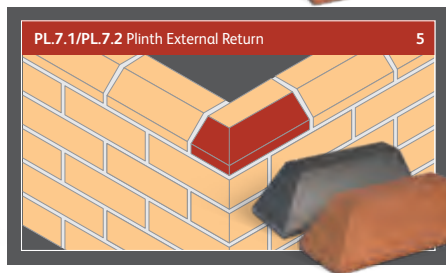
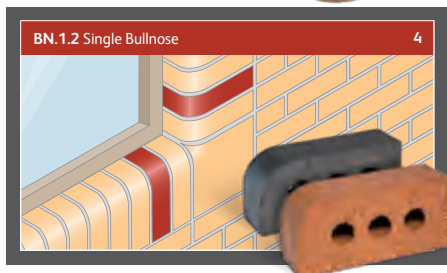
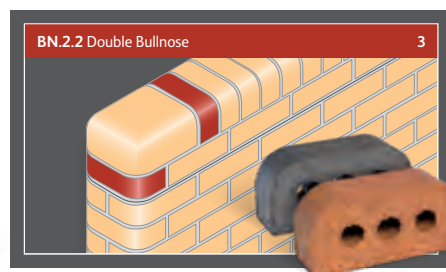
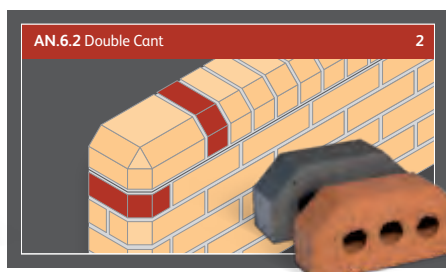
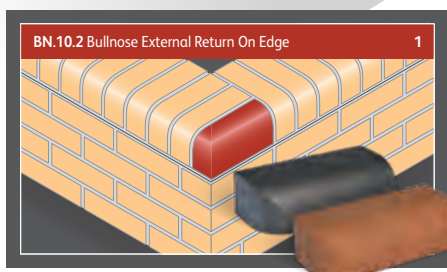

Build something *special*

### All Everyday Range of special shapes are:

- Manufactured to BS 4729.
- Guaranteed frost resistant to suit most brickwork applications.
- Specially designed for the job, no cutting is required.

Available in:

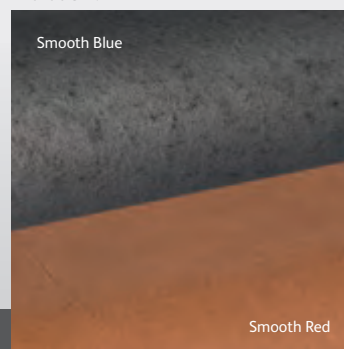

[IBSTOCKBRICK.CO.UK/KEVINGTON](http://IBSTOCKBRICK.CO.UK/KEVINGTON)



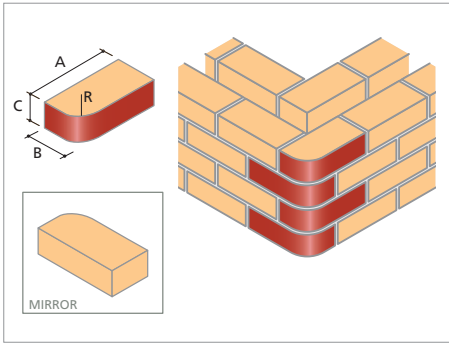

**BN.1 Single Bullnose (Left & Right Hand)**

TYPE NO.	A	B	C	R
BN.1.1	215	102	65	25
* BN.1.2	215	102	65	51

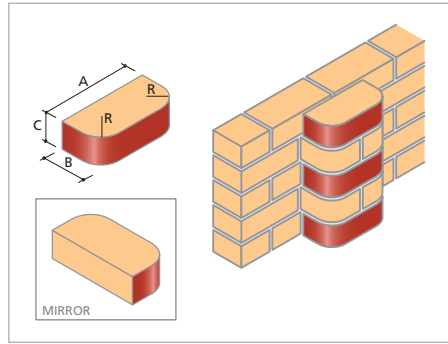

**BN.2 Double Bullnose**

TYPE NO.	A	B	C	R
BN.2.1	215	102	65	25
* BN.2.2	215	102	65	51

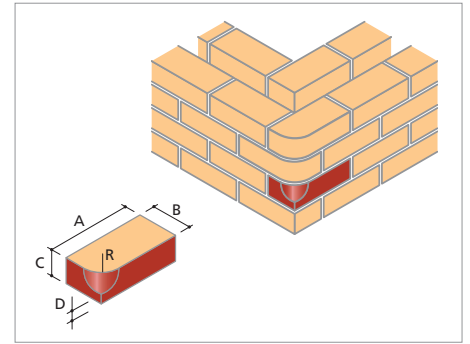

**BN.3 Single Bullnose Stop (Left & Right Hand)**

TYPE NO.	A	B	C	D	R
BN.3.1	215	102	65	25	25
BN.3.2	215	102	65	25	51

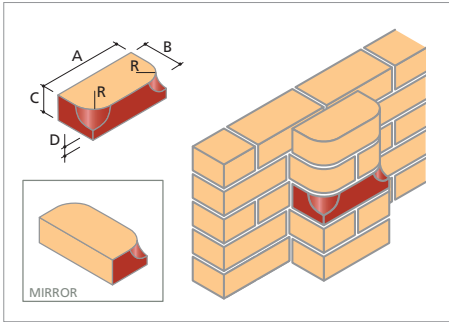

**BN.4 Double Bullnose Stop**

TYPE NO.	A	B	C	D	R
BN.4.1	215	102	65	25	25
BN.4.2	215	102	65	25	51

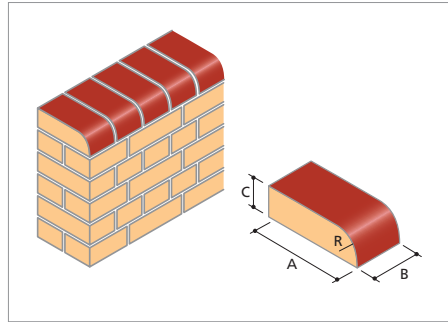

**BN.5 Single Bullnose Header On Flat**

TYPE NO.	A	B	C	R
BN.5.1	215	102	65	25
BN.5.2	215	102	65	51

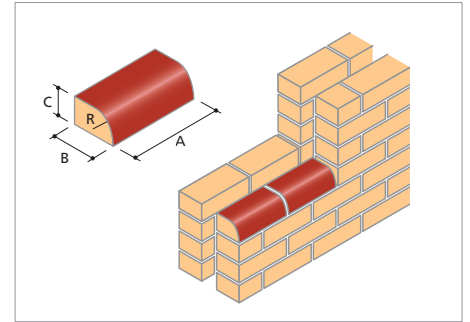

**BN.6 Single Bullnose Stretcher On Flat**

TYPE NO.	A	B	C	R
BN.6.1	215	102	65	25
BN.6.2	215	102	65	51

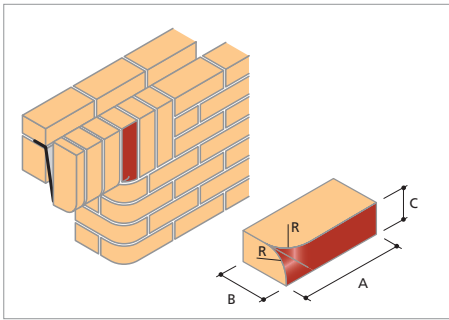

**BN.7 Single Bullnose Internal Return Stretcher Faced (Left & Right Hand)**

TYPE NO.	A	B	C	R
BN.7.1	215	102	65	25
BN.7.2	215	102	65	51
BN.7.3	215	102	215	25
BN.7.4	215	102	215	51

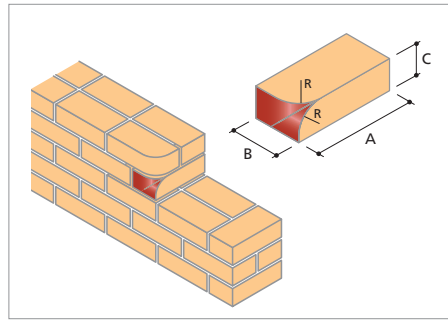

**BN.8 Single Bullnose Internal Return Header Faced (Left & Right Hand)**

TYPE NO.	A	B	C	R
BN.8.1	215	102	65	25
BN.8.2	215	102	65	51
BN.8.3	215	102	102	25
BN.8.4	215	102	102	51

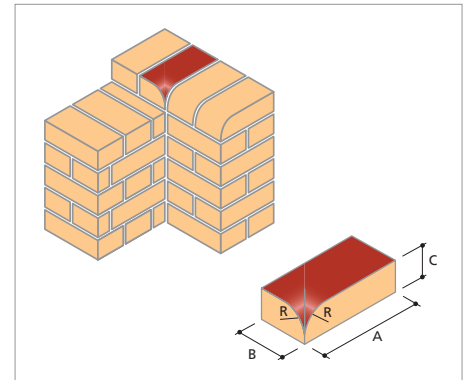

**BN.9 Single Bullnose Internal Return Flat Faced (Left & Right Hand)**

TYPE NO.	A	B	C	R
BN.9.1	215	102	65	25
BN.9.2	215	102	65	51

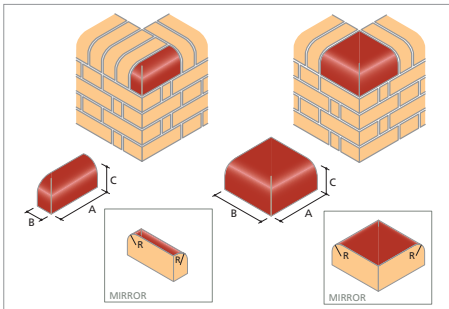

**BN.10 Bullnose External Return On Edge (Left & Right Hand)**

TYPE NO.	A	B	C	R
BN.10.1	215	65	102	25
* BN.10.2	215	65	102	51
BN.10.3	215	215	102	25
BN.10.4	215	215	102	51

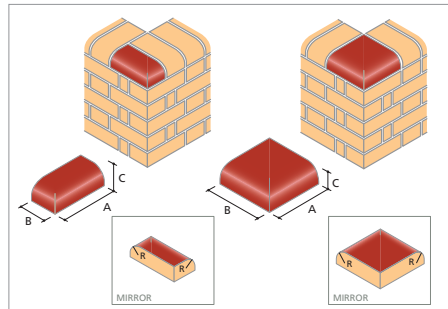

**BN.11 Bullnose External Return On Flat (Left & Right Hand)**

TYPE NO.	A	B	C	R
BN.11.1	215	102	65	25
BN.11.2	215	102	65	51
BN.11.3	215	215	65	25
BN.11.4	215	215	65	51

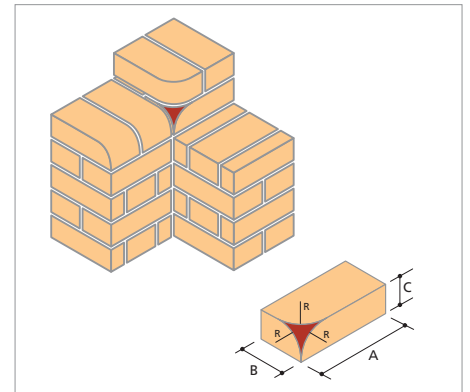

**BN.12 Bullnose Mitre (Left & Right Hand)**

TYPE NO.	A	B	C	R
BN.12.1	215	102	65	25
BN.12.2	215	102	65	51



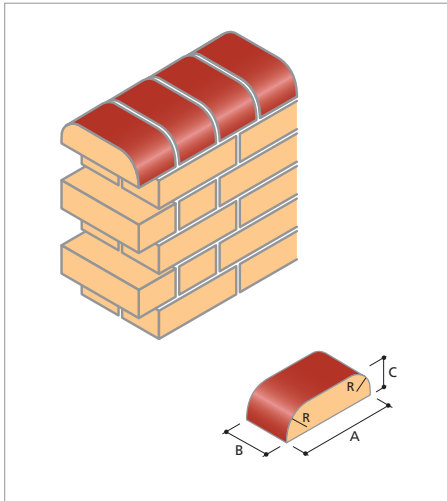

BN.13 Bullnose Double Header On Flat

TYPE NO.	A	B	C	R
BN.13.1	215	102	65	25
BN.13.2	215	102	65	51

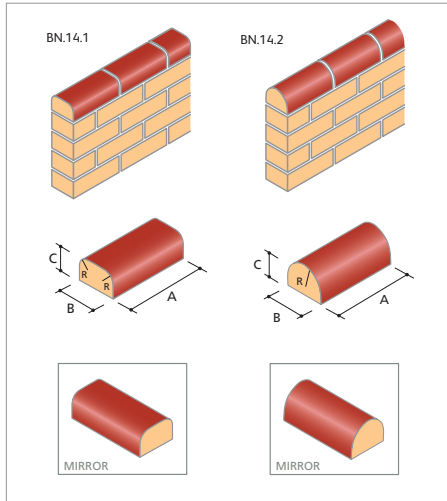

BN.14 Bullnose Double Stretcher On Flat

TYPE NO.	A	B	C	R
BN.14.1	215	102	65	25
BN.14.2	215	102	65	51

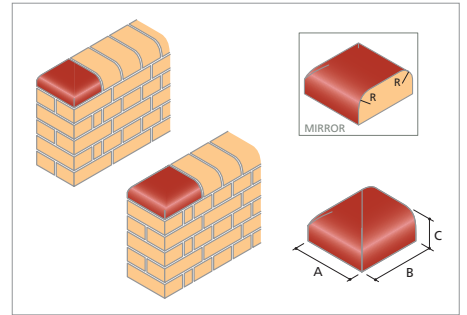

BN.15 Stop End to Double Bullnose On Edge and to Bullnose Double Header On Flat (Square Corners On Bed)

TYPE NO.	A	B	C	R
BN.15.1	215	159	102	25
BN.15.2	215	159	102	51
BN.15.3	215	215	102	25
BN.15.4	215	215	102	51
BN.15.5	215	159	65	25
BN.15.6	215	159	65	51
BN.15.7	215	215	65	25
BN.15.8	215	215	65	51

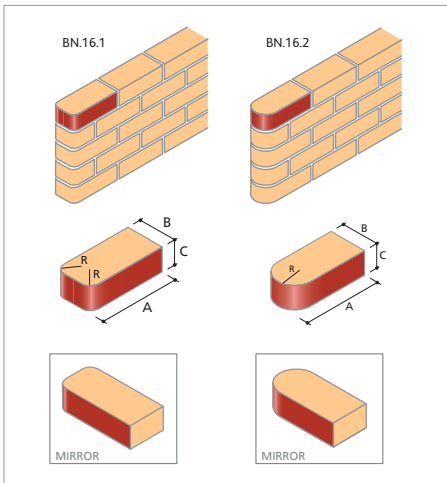

BN.16 Cownose

TYPE NO.	A	B	C	R
BN.16.1	215	102	65	25
BN.16.2	215	102	65	51

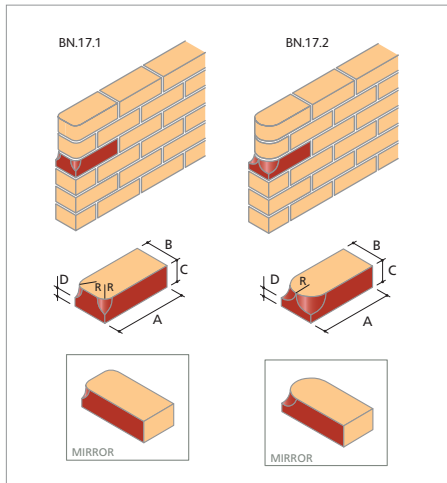

BN.17 Cownose Stop

TYPE NO.	A	B	C	D	R
BN.17.1	215	102	65	25	25
BN.17.2	215	102	65	25	51

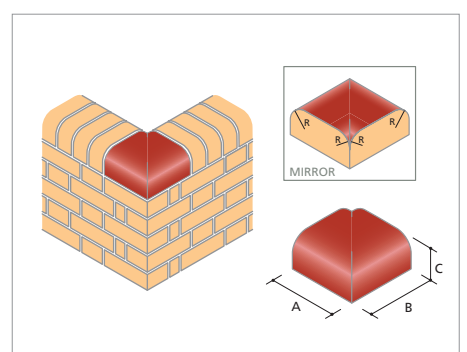

BN.19 External Return to Double Bullnose On Edge and to Bullnose Double Header On Flat (Square Corner On Bed)

TYPE NO.	A	B	C	R
BN.19.1	215	215	102	25
BN.19.2	215	215	102	51
BN.19.3	215	215	65	25
BN.19.4	215	215	65	51

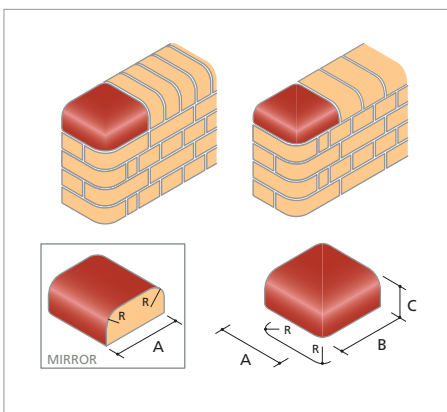

BN.18 Stop End to Double Bullnose On Edge and to Bullnose Double Header On Flat (Rounded Corners On Bed)

TYPE NO.	A	B	C	R
BN.18.1	215	159	102	25
BN.18.2	215	159	102	51
BN.18.3	215	215	102	25
BN.18.4	215	215	102	51
BN.18.5	215	159	65	25
BN.18.6	215	159	65	51
BN.18.7	215	215	65	25
BN.18.8	215	215	65	51

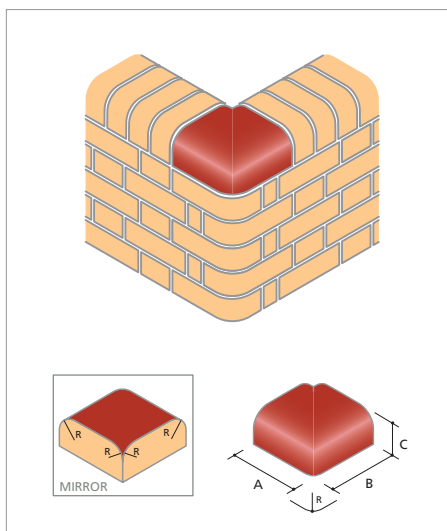

BN.20 External Return to Double Bullnose On Edge and to Bullnose Double Header On Flat (Rounded Corner On Bed)

TYPE NO.	A	B	C	R
BN.20.1	215	215	102	25
BN.20.2	215	215	102	51
BN.20.3	215	215	65	25
BN.20.4	215	215	65	51

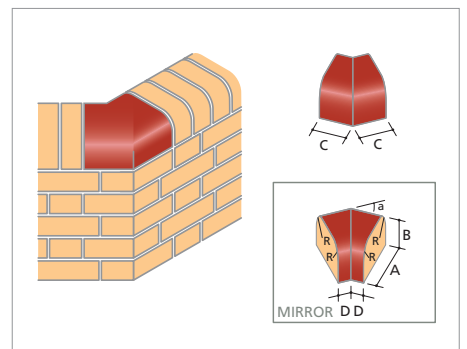

BN.21 Double Bullnose External Angle to Double Bullnose On Edge and to Bullnose Double Header On Flat

TYPE NO.	A	B	C	D	R	a
BN.21.1	215	102	159	101	25	30°
BN.21.2	215	102	159	101	51	30°
BN.21.3	215	65	159	101	25	30°
BN.21.4	215	65	159	101	51	30°
BN.21.5	215	102	159	70	25	45°
BN.21.6	215	102	159	70	51	45°
BN.21.7	215	65	159	70	25	45°
BN.21.8	215	65	159	70	51	45°
BN.21.9	215	102	159	35	25	60°
BN.21.10	215	102	159	35	51	60°
BN.21.11	215	65	159	35	25	60°
BN.21.12	215	65	159	35	51	60°



# SHELF ANGLE BRICKS

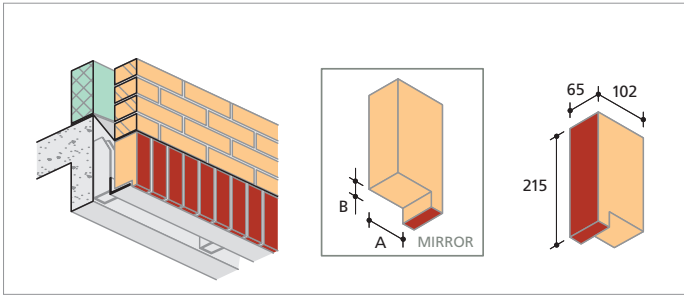

I.SA.1 Rebated Soldier

TYPE NO.	A	B
I.SA.1.1	82	15
I.SA.1.2	82	25
I.SA.1.3	82	35
I.SA.1.4	77	15
I.SA.1.5	77	25

TYPE NO.	A	B
I.SA.1.6	77	35
I.SA.1.7	72	15
I.SA.1.8	72	25
I.SA.1.9	72	35

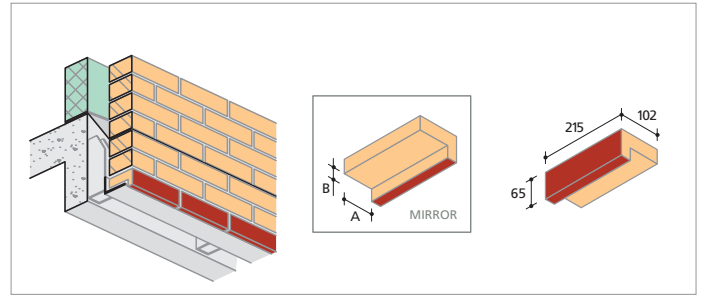

I.SA.4 Rebated Stretcher

TYPE NO.	A	B
I.SA.4.1	82	15
I.SA.4.2	82	25
I.SA.4.3	82	35
I.SA.4.4	77	15
I.SA.4.5	77	25

TYPE NO.	A	B
I.SA.4.6	77	35
I.SA.4.7	72	15
I.SA.4.8	72	25
I.SA.4.9	72	35

# SOLDIER BRICKS

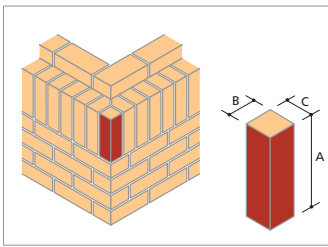

SD.1 Soldier External Return

TYPE NO.	A	B	C
SD.1.1	215	65	65
SD.1.2	215	102	102

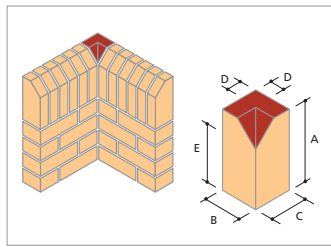

SD.2 Soldier Internal Return To Single Cant On End\*

TYPE NO.	A	B	C	D	E
SD.2.1	215	102	102	46	159
SD.2.2	215	102	102	60	173

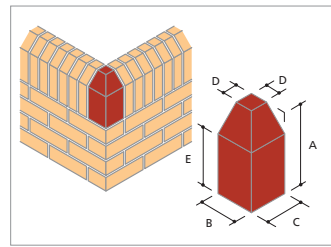

SD.3 Soldier External Return To Single Cant On End\*

TYPE NO.	A	B	C	D	E
SD.3.1	215	102	102	46	159
SD.3.2	215	102	102	60	173

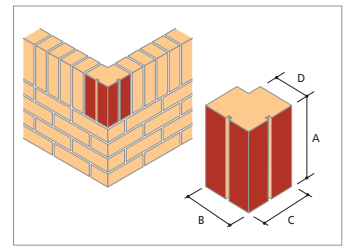

SD.1 Soldier External Return

TYPE NO.	A	B	C	D
I.SD.4	215	140	140	102

\* May be used in Sill or Plinth situations.

# EASYANGLE® & UNIVERSAL JOINT BRICKS

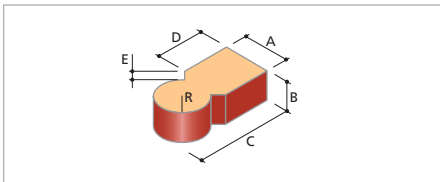

I.UJ.1 Universal Joint Male

TYPE NO.	A	B	C	D	E	R
I.UJ.1	102	65	215	106	26	51

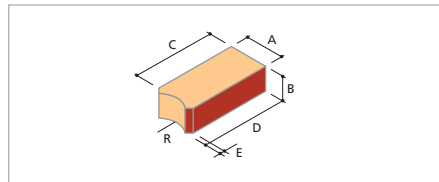

I.UJ.2 Universal Joint Female

TYPE NO.	A	B	C	D	E	R
I.UJ.2	102	65	218	230	12	61

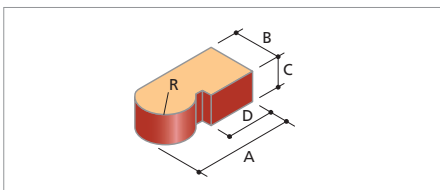

I.UJ.7 Easyangle® (Left & Right Hand)

TYPE NO.	A	B	C	D	R
* I.UJ.7.1	215	102	65	102	54

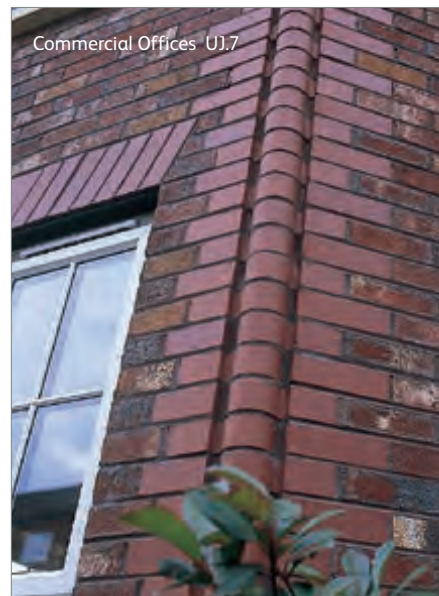
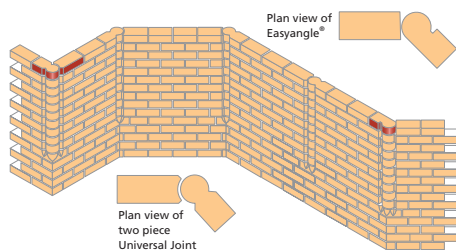

# SPIRAL & PINEAPPLE BRICKS

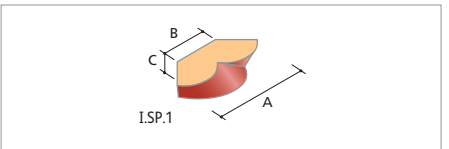

I.SP.1 Spiral Brick To 400mm Diameter Column

TYPE NO.	A	B	C	HELIX ROTATION
I.SP.1.1	275	180	65	Clockwise
I.SP.1.2	275	180	65	Anti-clockwise

I.SP.2 Spiral Brick To 600mm Diameter Column

TYPE NO.	A	B	C	HELIX ROTATION
I.SP.2.1	220	143	65	Clockwise
I.SP.2.2	220	143	65	Anti-clockwise

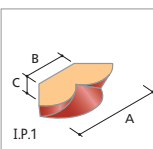

I.P.1 Pineapple Brick To 400mm Diameter Column



Private House, West Malling, Kent Parham Red Stock, I.SP.2 Spiral Brick to 600mm Diameter Column

I.P.1 Pineapple Brick To 400mm Diameter Column

TYPE NO.	A	B	C
I.P.1	275	180	65

I.P.2 Pineapple Brick To 600mm Diameter Column

TYPE NO.	A	B	C
I.P.2	220	143	65



# PLINTH BRICKS

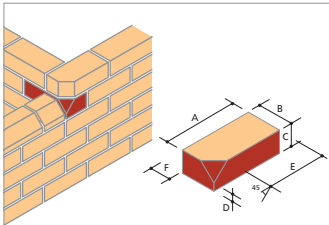

PL.1 Plinth Stop Or Cant Stop (Left & Right Hand)\*

TYPE NO.	A	B	C	D	E	F
● PL.1.1	215	102	65	9	159	46
● PL.1.2	215	102	65	23	173	60

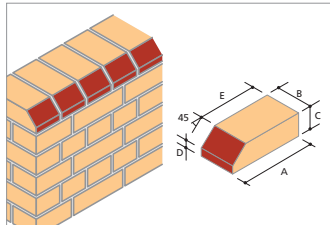

PL.2 Plinth Header\*

TYPE NO.	A	B	C	D	E
* PL.2.1	215	102	65	9	159
* PL.2.2	215	102	65	23	173

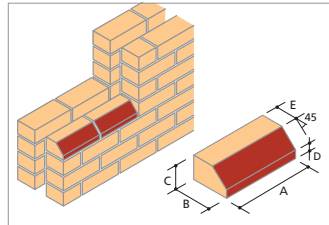

PL.3 Plinth Stretcher\*

TYPE NO.	A	B	C	D	E
* PL.3.1	215	102	65	9	46
* PL.3.2	215	102	65	23	60

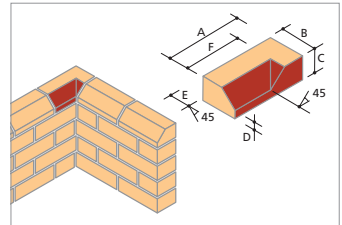

PL.4 Plinth Internal Return - long (Left & Right Hand)\*

TYPE NO.	A	B	C	D	E	F
* PL.4.1	215	102	65	9	46	169
* PL.4.2	215	102	65	23	60	155

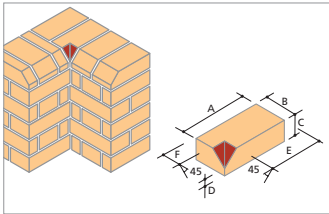

PL.5 Plinth Internal Return - short (Left & Right Hand)\*

TYPE NO.	A	B	C	D	E	F
PL.5.1	215	102	65	9	159	46
PL.5.2	215	102	65	23	173	60

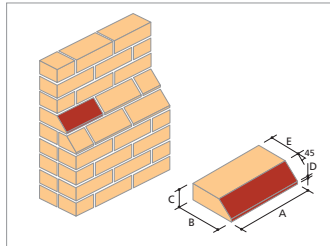

I.PL.15 Wide Bed Plinth Stretcher

TYPE NO.	A	B	C	D	E
I.PL.15.1	215	158	65	9	102

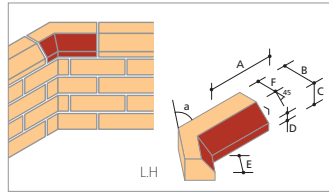

PL.6 Plinth Internal Angle (Left & Right Hand)\*

TYPE NO.	A	B	C	D	E	F	a
PL.6.1+	164	102	65	9	51	46	30°
PL.6.2+	164	102	65	23	51	60	30°
PL.6.3+	164	102	65	9	51	46	45°
PL.6.4+	164	102	65	23	51	60	45°
PL.6.5+	164	102	65	9	51	46	60°
PL.6.6+	164	102	65	23	51	60	60°

PL.6.7♦	159	102	65	9	102	46	30°
PL.6.8♦	159	102	65	23	102	60	30°
PL.6.9♦	159	102	65	9	102	46	45°
PL.6.10♦	159	102	65	23	102	60	45°
PL.6.11♦	159	102	65	9	102	46	60°
PL.6.12♦	159	102	65	23	102	60	60°

PL.6.13+	215	102	65	9	102	46	30°
PL.6.14+	215	102	65	23	102	60	30°
PL.6.15+	215	102	65	9	102	46	45°
PL.6.16+	215	102	65	23	102	60	45°
PL.6.17+	215	102	65	9	102	46	60°
PL.6.18+	215	102	65	23	102	60	60°

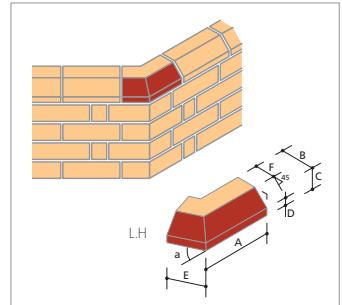

PL.8 Plinth External Angle (Left & Right Hand)\*

TYPE NO.	A	B	C	D	E	F	a
PL.8.1♦	159	102	65	9	102	46	30°
PL.8.2♦	159	102	65	23	102	60	30°
PL.8.3♦	159	102	65	9	102	46	45°
PL.8.4♦	159	102	65	23	102	60	45°
PL.8.5♦	159	102	65	9	102	46	60°
PL.8.6♦	159	102	65	23	102	60	60°

PL.8.7+	215	102	65	9	102	46	30°
PL.8.8+	215	102	65	23	102	60	30°
PL.8.9+	215	102	65	9	102	46	45°
PL.8.10+	215	102	65	23	102	60	45°
PL.8.11+	215	102	65	9	102	46	60°
PL.8.12+	215	102	65	23	102	60	60°

- \* Extra faces available.
- + Suitable for half bond without cutting.
- ♦ Suitable for quarter bond without cutting.

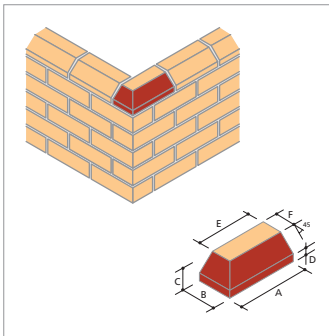

PL.5 Plinth Internal Return - short (Left & Right Hand)\*

TYPE NO.	A	B	C	D	E	F
PL.7.1	215	102	65	9	159	46
PL.7.2	215	102	65	23	173	60

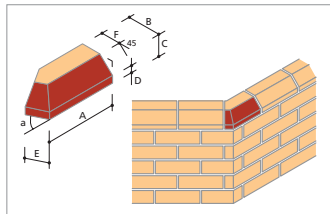

PL.9 Plinth Squint (Left & Right Hand)\*

TYPE NO.	A	B	C	D	E	F	a
PL.9.1+	164	102	65	9	51	46	30°
PL.9.2+	164	102	65	23	51	60	30°
PL.9.3+	164	102	65	9	51	46	45°
PL.9.4+	164	102	65	23	51	60	45°
PL.9.5+	164	102	65	9	51	46	60°
PL.9.6+	164	102	65	23	51	60	60°

# BONDING BRICKS

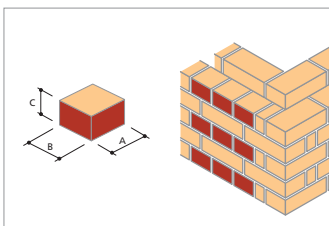

BD.1.1 Half Bat (Snap Header)

TYPE NO.	A	B	C
BD.1.1	102	102	65

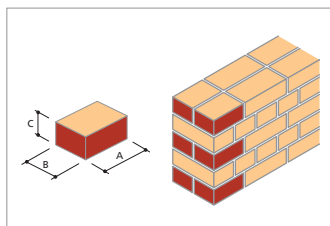

BD.1.2 Three-quarter Bat

TYPE NO.	A	B	C
BD.1.2	159	102	65

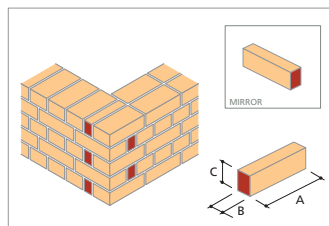

BD.3 Queen Closer

TYPE NO.	A	B	C
BD.3	215	46	65

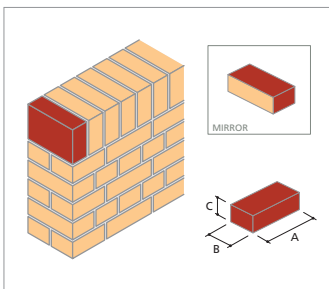

BD.1.3 Standard Brick fair-faced On Bed Surface

TYPE NO.	A	B	C
* BD.1.3	215	102	65

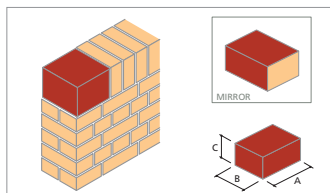

BD.4 215mm Square Stop End

TYPE NO.	A	B	C
BD.4.1	215	159	102
BD.4.2	215	159	65
BD.4.3	215	215	102
BD.4.4	215	215	65

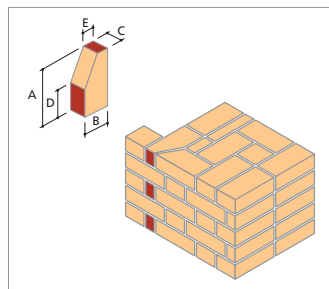

BD.2 King Closer

TYPE NO.	A	B	C	D	E
BD.2	215	102	65	102	46

# SLIP BRICKS

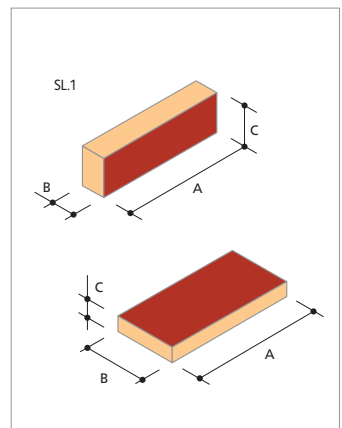

SL.1 Brick Face Slip

TYPE NO.	A	B	C
SL.1.1	215	25	65
SL.1.2	215	30	65
SL.1.3	215	40	65
SL.1.4	215	50	65

SL.2 Brick Bed Slip

TYPE NO.	A	B	C
SL.2	215	102	25



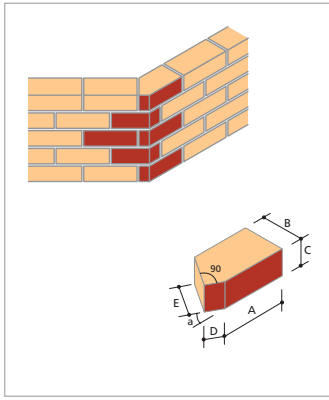

**AN.1 Squint Brick (Left & Right Hand)**

TYPE NO.	A	B	C	D	E	a
AN.1.1+	164	102	65	51	89	30°
* AN.1.2+	164	102	65	51	94	45°
* AN.1.3+	164	102	65	51	117	60°

+ Suitable for half bond without cutting.  
 \* Suitable for quarter bond without cutting.

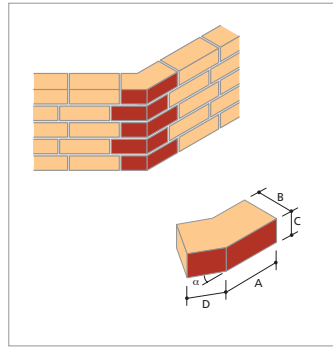

**AN.2 External Angle (Left & Right Hand)**

TYPE NO.	A	B	C	D	E
AN.2.1♦	159	102	65	102	30°
* AN.2.2♦	159	102	65	102	45°
* AN.2.3♦	159	102	65	102	60°
AN.2.4+	215	102	65	102	30°
AN.2.5+	215	102	65	102	45°
AN.2.6+	215	102	65	102	60°

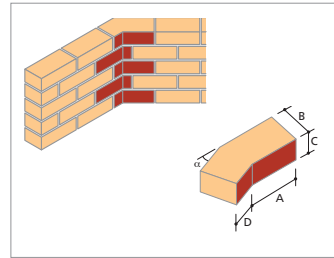

**AN.3 Internal Angle (Dog Leg) (Left & Right Hand)**

TYPE NO.	A	B	C	D	E
AN.3.1+	164	102	65	51	30°
* AN.3.2+	164	102	65	51	45°
AN.3.3+	164	102	65	51	60°
AN.3.4♦	159	102	65	102	30°
AN.3.5♦	159	102	65	102	45°
AN.3.6♦	159	102	65	102	60°
AN.3.7+	215	102	65	102	30°
AN.3.8+	215	102	65	102	45°
AN.3.9+	215	102	65	102	60°

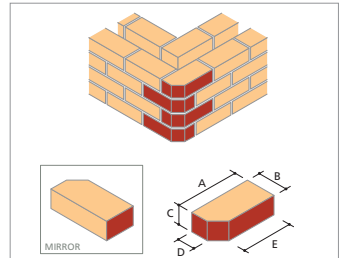

**AN.5 Single Cant (Left & Right Hand)**

TYPE NO.	A	B	C	D	E
AN.5.1	215	102	65	46	159
* AN.5.2	215	102	65	60	173

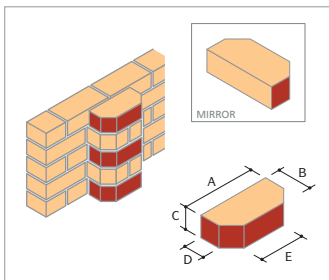

**AN.6 Double Cant**

TYPE NO.	A	B	C	D	E
AN.6.1	215	102	65	46	103
* AN.6.2	215	102	65	60	131

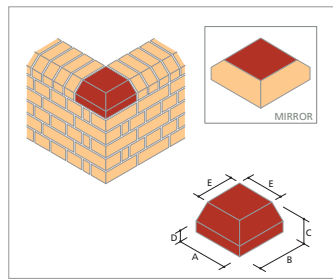

**AN.7 Single Cant External Return**

TYPE NO.	A	B	C	D	E
● AN.7.1	215	215	102	46	159
● AN.7.2	215	215	102	60	173

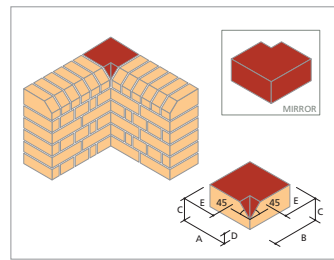

**AN.8 Single Cant Internal Return With Internal Mitre (Square External Corner On Bed)**

TYPE NO.	A	B	C	D	E
AN.8.1	215	215	102	46	159
AN.8.2	215	215	102	60	173

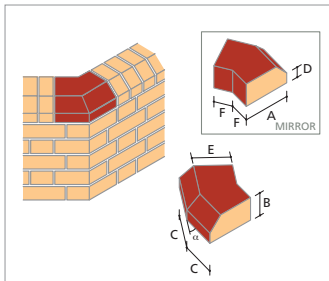

**AN.10 Single Cant External Angle**

TYPE NO.	A	B	C	D	E	F	a
AN.10.1	215	102	159	46	159	101	30°
AN.10.2	215	102	159	60	173	101	30°
AN.10.3	215	102	159	46	159	70	45°
AN.10.4	215	102	159	60	173	70	45°
AN.10.5	215	102	159	46	159	35	60°
AN.10.6	215	102	159	60	173	35	60°

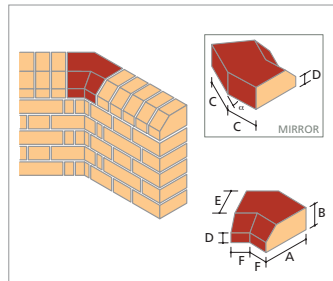

**AN.11 Single Cant Internal Angle**

TYPE NO.	A	B	C	D	E	F	a
AN.11.1	215	102	159	46	159	101	30°
AN.11.2	215	102	159	60	173	101	30°
AN.11.3	215	102	159	46	159	70	45°
AN.11.4	215	102	159	60	173	70	45°
AN.11.5	215	102	159	46	159	35	60°
AN.11.6	215	102	159	60	173	35	60°

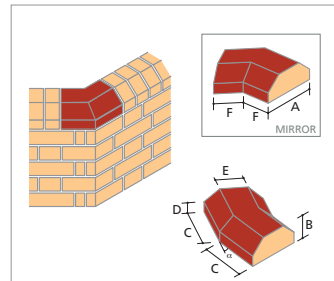

**AN.18 Double Cant Angle**

TYPE NO.	A	B	C	D	E	F	a
AN.18.1	215	102	159	46	103	101	30°
AN.18.2	215	102	159	60	131	101	30°
AN.18.3	215	102	159	46	103	70	45°
AN.18.4	215	102	159	60	131	70	45°
AN.18.5	215	102	159	46	103	35	60°
AN.18.6	215	102	159	60	131	35	60°

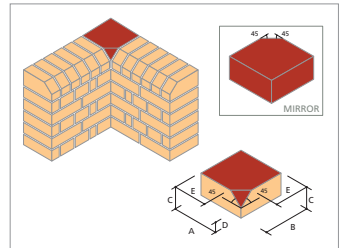

**AN.9 Single Cant Internal Return With Internal Slope (Square External Corner On Bed)**

TYPE NO.	A	B	C	D	E
AN.9.1	215	215	102	46	159
AN.9.2	215	215	102	60	173

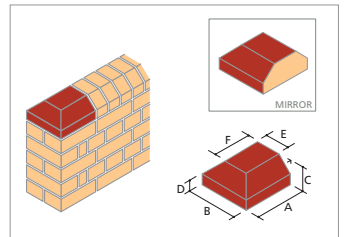

**AN.12 Double Cant Stop End (Square Corners On Bed)**

TYPE NO.	A	B	C	D	E	F
● AN.12.1	215	215	102	46	103	159
● AN.12.2	215	215	102	60	131	173

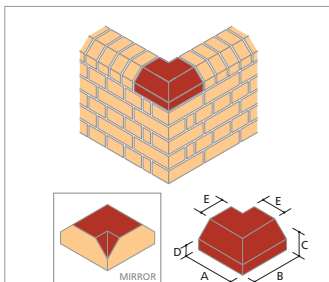

**AN.14 Double Cant External Return With Internal Mitre (Square Corner On Bed)**

TYPE NO.	A	B	C	D	E
AN.14.1	215	215	102	46	103
AN.14.2	215	215	102	60	131

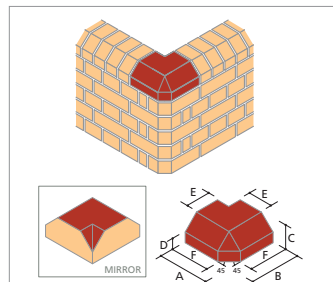

**AN.15 Double Cant External Return With Internal Mitre (Canted Corner On Bed)**

TYPE NO.	A	B	C	D	E	F
AN.15.1	215	215	102	46	103	159
AN.15.2	215	215	102	60	131	173

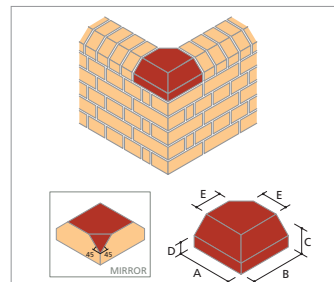

**AN.16 Double Cant External Return With Internal Slope (Square Corner On Bed)**

TYPE NO.	A	B	C	D	E
AN.16.1	215	215	102	46	103
AN.16.2	215	215	102	60	131

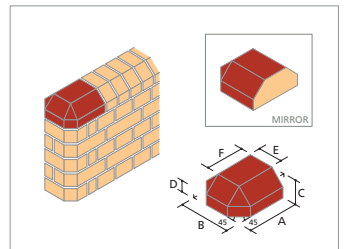

**AN.13 Double Cant Stop End (Canted Corners On Bed)**

TYPE NO.	A	B	C	D	E	F
AN.13.1	215	215	102	46	103	159
AN.13.2	215	215	102	60	131	173

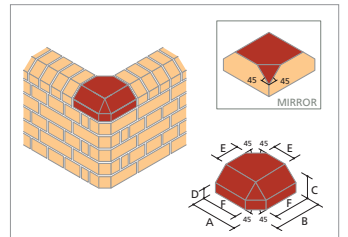

**AN.17 Double Cant External Return With Internal Slope (Canted Corners On Bed)**

TYPE NO.	A	B	C	D	E	F
AN.17.1	215	215	102	46	103	159
AN.17.2	215	215	102	60	131	173

● To complement the Everyday Range, Ibstock Kevington provides the perfect design details to finish off corners.



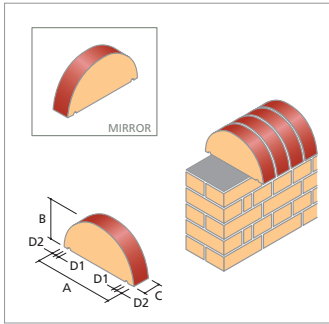

CP.1.1 Half Round Copping

TYPE NO.	A	B	C	D1	D2
CP.1.1	305	153	65	13	15

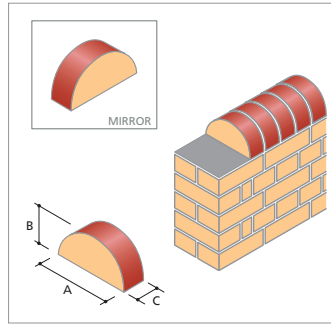

CP.1.2 Half Round Copping

TYPE NO.	A	B	C
CP.1.2	215	108	65

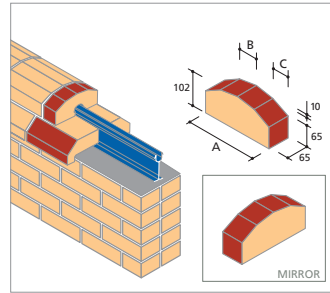

I.F.1 Faceted Copping †

TYPE NO.	A	B	C
I.F.1.1	215	65.5	42
I.F.1.2* ■	255	77.5	50

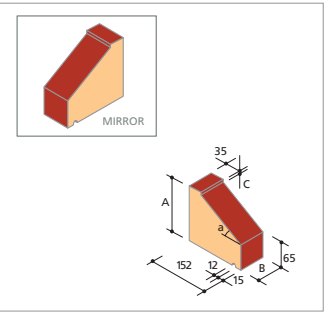

I.C.1 Overhanging Angled Sill

TYPE NO.	A	B	C	a
I.C.1.1	140	65	7.5	30°
I.C.1.2	140	102	7.5	30°
I.C.1.3	140	215	7.5	30°
I.C.1.4	215	65	10	50°
I.C.1.5	215	102	10	50°
I.C.1.6	215	215	10	50°

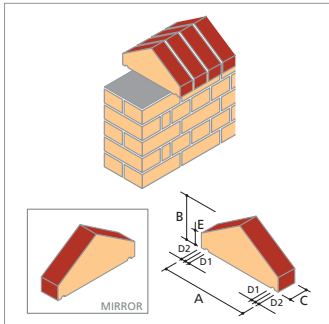

CP.2.1 Saddleback Copping

TYPE NO.	A	B	C	D1	D2	E
CP.2.1	305	153	65	13	15	50

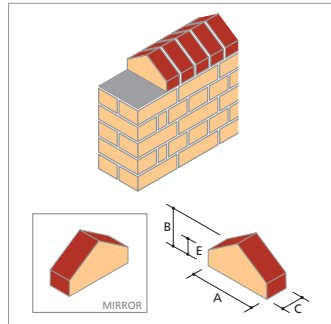

CP.2.2 Saddleback Copping

TYPE NO.	A	B	C	E
CP.2.2	215	123	65	50

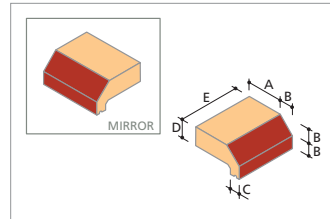

I.B.C.1 Base Copping Standard Brick\*\*

TYPE NO.	A	B	C	D	E
I.B.C.1.1	102	45	35	65	215
I.B.C.1.2* ■	122	45	35	65	215

- Cavity wall.
- † Other widths available.
- \* Extra faces available.
- \*\* Can be cut to form incline to transition cuit.

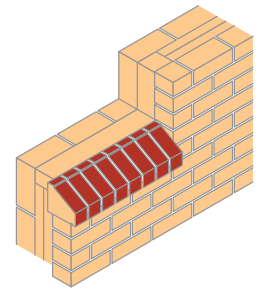

## ARCH BRICKS

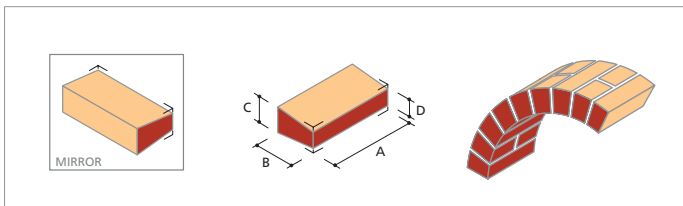

AR.1 Tapered Header

TYPE NO.	UNIT DIMENSIONS				IDEAL SPAN	NO. OF WHOLE BRICKS (SPAN)	NO. OF BRICKS IN SEMI CIRCLE
	A	B	C	D			
AR.1.1	215	102	75	59	910	4	20 or 21
I.AR.1.1-1*	215	102	75	62	1135	5	24 or 25
AR.1.2	215	102	75	64	1360	6	28 or 29
I.AR.1.2-1*	215	102	75	65	1585	7	32 or 33
AR.1.3	215	102	75	66	1810	8	36 or 37
I.AR.1.3-1*	215	102	75	67	2260	10	45 or 46
AR.1.4	215	102	75	69	2710	12	53 or 54

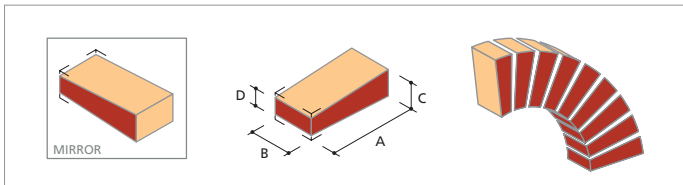

AR.2 Tapered Stretcher

TYPE NO.	UNIT DIMENSIONS				IDEAL SPAN DIMENSION	NO. OF WHOLE BRICKS (SPAN)	NO. OF BRICKS IN SEMI CIRCLE
	A	B	C	D			
AR.2.1	215	102	75	48	910	4	25
I.AR.2.1-1*	215	102	75	51	1135	5	29
AR.2.2	215	102	75	55	1360	6	33
I.AR.2.2-1*	215	102	75	57	1585	7	37
AR.2.3	215	102	75	58	1810	8	41
I.AR.2.3-1*	215	102	75	61	2260	10	50
AR.2.4	215	102	75	63	2710	12	58

\* Ibstock Specials to create a wider choice of arch spans. Bullnose and Cant profiles are available.

## RADIAL BRICKS

RD.1 Radial Header

TYPE NO.	UNIT DIMENSIONS				IDEAL RADIUS		NO. OF BRICKS IN QUADRANT
	A	B	C	D	OUTER	INNER	
RD.1.1	215	108	65	52	450	235	6
RD.1.2	215	108	65	70	675	460	9
RD.1.3	215	108	65	80	900	685	12
I.RD.1.3-1	215	108	65	85	1125	910	15
RD.1.4	215	108	65	89	1350	1135	18
I.RD.1.4-1	215	108	65	94	1800	1585	24
RD.1.5	215	108	65	97	2250	2035	30
I.RD.1.5-1	215	108	65	101	3600	3385	48
RD.1.6	215	108	65	103	5400	5185	72

NOTE: Radial Bricks are normally manufactured flat backed unless specified otherwise.

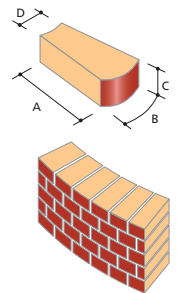

RD.2 Radial Stretcher

TYPE NO.	UNIT DIMENSIONS				IDEAL RADIUS		NO. OF BRICKS IN QUADRANT
	A	B	C	D	OUTER	INNER	
RD.2.1	226	102	65	172	450	347	3
RD.2.2	226	102	65	190	675	572	4.5
RD.2.3	226	102	65	199	900	797	6
I.RD.2.3-1	226	102	65	204	1125	1022	7.5
RD.2.4	226	102	65	208	1350	1247	9
I.RD.2.4-1	226	102	65	212	1800	1697	12
RD.2.5	226	102	65	215	2250	2147	15
I.RD.2.5-1	226	102	65	219	3600	3497	24
RD.2.6	226	102	65	221	5400	5297	36

NOTE: To be used in conjunction with I.RD.3, radial to straight transition bricks.  
NOTE: Radial Bricks are normally manufactured flat backed unless specified otherwise.

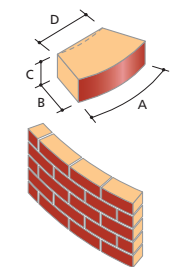

RD.2 Radial Stretcher

TYPE NO.	UNIT DIMENSIONS				IDEAL RADIUS		NO. OF BRICKS IN QUADRANT
	A	B	C	D	OUTER	INNER	
I.RD.3.1	108	102	65	198	450	347	3
I.RD.3.2	108	102	65	204	675	572	4.5
I.RD.3.3	108	102	65	208	900	797	6
I.RD.3.4	108	102	65	211	1125	1022	7.5
I.RD.3.5	108	102	65	212	1350	1247	9
I.RD.3.6	108	102	65	214	1800	1697	12
I.RD.3.7	108	102	65	215	2250	2147	15
I.RD.3.8	108	102	65	217	3600	3497	24
I.RD.3.9	108	102	65	218	5400	5297	36

NOTE: To be used in conjunction with I.RD.3, radial to straight transition bricks.  
NOTE: Radial Bricks are normally manufactured flat backed unless specified otherwise.

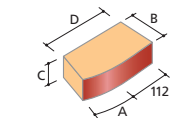





# Ibstock Kevington

## FASTSTACK® CHIMNEYS

Our chimneys can be used with most appliances including class 1 multi-fuel stoves

TIME SAVING  
CHIMNEY BUILDING  
IN **7** EASY STEPS

- ✓ 1 - Delivered ready for pointing
- ✓ 2 - Crane into position
- ✓ 3 - Screw to trusses
- ✓ 4 - Batten over support plate & tile roof
- ✓ 5 - Apply sealant
- ✓ 6 - Lead dressed securely
- ✓ 7 - JOB DONE!

**LIGHTWEIGHT  
GRP BRICK EFFECT**  
VERSIONS NOW  
ALSO AVAILABLE

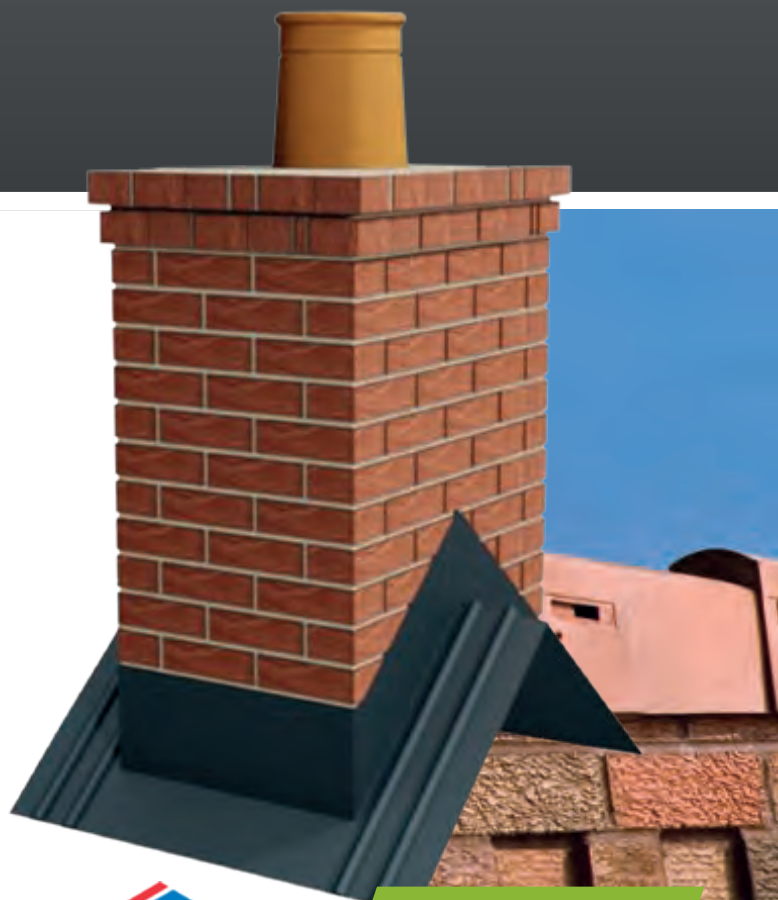

**ALL OUR CHIMNEYS  
CAN BE MADE USING  
ANY BRICK OR STONE**



### MONO PITCH

Mono Pitch chimneys are for use on the pitch (slope) of the roof.



### GABLE END RIDGES

The Gable End Ridge chimneys are designed to allow the brickwork to continue from the gable wall into the chimney unit.



### MID RIDGE

In situations where the chimneys are not located directly over the gable wall, the Mid Ridge design can be used.



Ibstock Kevington is the UK's leading manufacturer of special shape bricks, arches, prefabricated chimneys and building components. Our in house design and sales teams offer unrivalled expertise and experience. Take a look at some of the fantastic products on offer...

### ALL BRICKWORK COMPONENTS

CAN BE MANUFACTURED IN ANY BRICK OR STONE

## DENTILS & SOLDIERS

Use bricks in an imaginative way



### BRICK TYPES

#### DENTILS

Dentilation is a tooth-like effect created by the projection of alternate headers or cut bricks, usually seen at eaves level or as a string course. In today's brick aesthetics, dentil courses offer a decorative opportunity which deserves wider use. It's easy to design a dentil detail with Brickwork Component units.



#### SOLDIER COURSES

Soldier Courses are produced by laying the bricks on end, side by side. Traditionally this style of brickwork is used both above and below openings. Easily designed using Brickwork Component units, a soldier can also be used to create a horizontal band course around a building.



Ask your stockist for more information or call our Sales Office on **0844 736 0350**





# Ibstock Kevington

## ARCHES & BULLSEYES

Brickwork details made easy - design flexibility, quick to install, consistent quality, time-saving and can be lightweight.



Our arches and bullseyes are popular with small builders as well as large developers. Arches are often thought of as changing a building into a home as they add character by creating a point of interest and give that extra kerb appeal. Whether your arch is over a window, door, garage door or a walkway, our arches can span the distance.

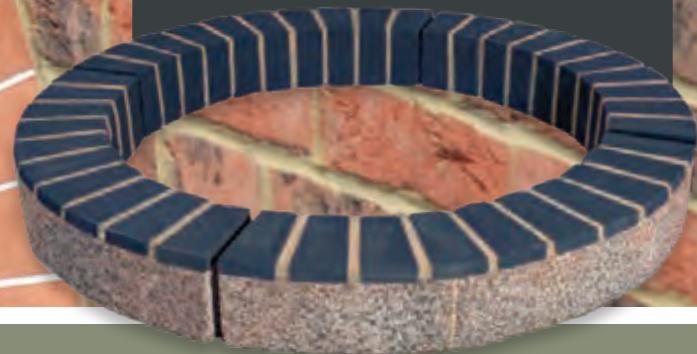

## SWIFT & BAT BOXES

Friendly habitats for  
bats and swifts.

### ENCLOSED SWIFT BOX

Swifts come to the UK for just a few months each summer from Central and Southern Africa. Despite legal protection their numbers are declining. Since Roman times they have been at home in traditional man-made buildings. However they find it increasingly difficult to find nest sites in modern or refurbished buildings due to the effective sealing of the eaves.

- Developed for Swifts
- Locate near eaves
- Ideal for both new-build & conservation work
- Available in Smooth Red or Smooth Blue finishes



Ask your stockist for more information or call our Sales Office on **0844 736 0350**



## Ibstock Kevington understands the need to create exciting kerbside appeal.

Fitting our Brickwork Components is easy. They are quick to install and cost effective. Whatever your brick type, we can create your component; from our popular arch and bullseyes, sills, chimneys and dentil work to more decorative soldier courses, quoins, basketweave and herringbone panels.

# FEATURE HEADERS

Maintaining a tradition.



Glazed or burnt headers were often an accidental phenomenon of traditional kilns. The distinctive patterning formed by the headers is often seen in many solid walled buildings.

We have carefully recreated the authentic appearance for use with modern cavity wall construction. These are available in three ranges; traditionally glazed, kiln burnt naturally fired bricks and hand tinted bricks.

### HAND TINTED RANGE



Anthracite Blue/Grey FHTH55



Charcoal Black FHTH65



Ash Grey FHTH35

### TRADITIONAL GLAZED

### KILN BURNT RANGE



Parham Red Stock Glazed Header FH0708

Available in 65mm format only.



Swanage Handmade Light Red Glazed Header FH4302

Available in 65mm format only.



Tonbridge Handmade Grey Brown Header FH4041

Available in 65mm format, and 50mm to special order.



Bevern Dark Multi Stock Header FH4520

Available in 65mm format only.



Holbrook Sandfaced Dark Header FH4120

Available in 65mm format only.

### ENCLOSED BAT BOX (B & C)

In the UK there are 17 species of bats, all of which are protected by law. Our range of bat boxes helps to encourage safe habitats for these remarkable mammals, allowing them to live in harmony with people.

- Designed specifically for the pipistrelle bat
- Several roosting zones are created inside the box
- Bats are contained within the bat box itself
- Maintenance free with entrance at the base
- Ideal for new build & conservation work
- Attractive motif (option C only)
- Available in all brick types to match brickwork



BAT BOX B



BAT BOX C

Ask your stockist for more information or call our Sales Office on **0844 736 0350**



# FACTORY INDEX

94

BRICK SELECTOR 2019 FACTORY INDEX

ALDRIDGE		West Midlands
Product Code	Product	Colour & Page
A0270A	Aldridge Multi Rustic	26
C0270A	Aldridge Multi Rustic 73mm	26
A0257A	Anglian Red Multi Rustic	25
C0257A	Anglian Red Multi Rustic 73mm	25
A0352A	Anglian Red Rustic	14
C0352A	Anglian Red Rustic 73mm	14
C0356A	Anglian Ruskin Multi 73mm	25
A0273A	Chester Urban Blend	13
A0266A	Georgian Red Blend	25
A0350A	Madeley Mixture	24
C0350A	Madeley Mixture 73mm	24
A0269A	New Burntwood Red Rustic	26
C0269A	New Burntwood Red Rustic 73mm	26
C0256A	Ruskin Red 73mm	22
A0085A	Shireoak Russett	26
A0287A	Staffordshire Georgian	26
A0289A	Staffordshire Multi Rustic	26
C0289A	Staffordshire Multi Rustic 73mm	26
A0288A	Staffordshire Smooth	22
A0258A	Anglian Beacon Sahara	46
C0258A	Anglian Beacon Sahara 73mm	46
A0353A	Anglian Buff Multi Rustic	46
A0260A	Brown Blend	57
A0355A	Himley Dark Brown Rustic	57
A0358A	Himley Ash Grey	61
A0268A	Multi Grey Rustic	61
A0354A	Himley Ebony Black	65

ASHDOWN		East Sussex
Product Code	Product	Colour & Page
A4009A	Bexhill Dark	38
A4033A	Bexhill Purple Multi	38

ASHDOWN		East Sussex
Product Code	Product	Colour & Page
A4010A	Bexhill Red	38
A4001A	Cottage Mixture	38
A4004A	Pevensey Multi Stock	42
A4043A	Tonbridge Handmade Multi	43
B4043A	Tonbridge Handmade Multi 50mm	43
A4046A	West Hoathly Handmade Multi Stock	43
B4046A	West Hoathly Handmade Multi Stock 50mm	43
A4027A	Coleridge Yellow Multi	49
A4049A	Funton Harvest Mixture	50
A4053A	Funton Old Chelsea Yellow	49
D4053A	Funton Old Chelsea Yellow Imperial	49
A4050A	Funton Second Hard Stock	50
A4052A	London Reclaim Mixture	50
D4052A	London Reclaim Mixture Imperial	50
A4044A	Tonbridge Handmade Pastone	51
B4044A	Tonbridge Handmade Pastone 50mm	51
A4002A	Crowborough Multicoloured Stock	62
A4041A	Tonbridge Handmade Grey Brown	63
B4041A	Tonbridge Handmade Grey Brown 50mm	63
A4042A	Tonbridge Handmade Heather Grey	63
B4042A	Tonbridge Handmade Heather Grey 50mm	63

ATLAS		West Midlands
Product Code	Product	Colour & Page
A0376A	Aldridge Smooth Red	13
C0376A	Aldridge Smooth Red 73mm	13
A0378A	Aston Red Sandfaced	15
C0378A	Aston Red Sandfaced 73mm	15
A0300A	Atlas Smooth Red	13
C0300A	Atlas Smooth Red 73mm	13
A0335A	Himley Mixed Russet Original	23
A0317A	Himley Worcestershire Mixture	31

ATLAS		West Midlands
Product Code	Product	Colour & Page
A0334A	Stratford Red Dragface	14
A0333A	Stratford Red Rustic	14
A0389A	Tradesman® Antique Rustic Blend	32
C0389A	Tradesman® Antique Rustic Blend 73mm	32
A0385A	Tradesman® Cheviot	33
A0329A	Tradesman® Claygate Red Multi	33
A0383A	Tradesman® Rustic Blend	33
A0384A	Tradesman® Sandfaced Red Multi	27
A0323A	Tradesman® Tudor Regent	33
A0395A	Tradesman® Windsor Regent	17
C0383A	Tradesman® Rustic Blend 73mm	17
A0390A	Caledonian Buff Blend	53
A0100A	Earlwood Textured Buff	45
A0304A	Tradesman Buff Multi	54
C0381A	Tradesman® Heather Mixture 73mm	58
A0381A	Tradesman® Heather Mixture	58
A0314A	Tradesman® Antique Grey	61
A0382A	Tradesman® Light	61
C0382A	Tradesman® Light 73mm	61

BIRTLEY		County Durham
Product Code	Product	Colour & Page
A2601A	Beamish Blend	34
C2601A	Beamish Blend 73mm	34
A2602A	Birtley Olde English	34
C2602A	Birtley Olde English 73mm	34
A2631A	Borrowdale Blend	34
A2611A	Commercial Red	34
C2611A	Commercial Red 73mm	34
A2629A	Cumberland Blend	34
A2622A	Northumbrian Cottage	35
A2621A	Otterburn Antique	35

Stockist's top tip: Mix loads of different products from the following pairs of factories: Aldridge/Atlas; Aldridge/Lodge Lane; Atlas/Lodge Lane; Chailey/West Hoathly; Chesterton/Parkhouse; Laybrook/South Holmwood; Throckley/Birtley; West Hoathly/Laybrook. Charges may apply for this service.

The product photographs represent as accurately as possible, within the limitations of photography and printing, the colour of a representative sample of this range of products. However Istock Brick does not warrant that all bricks produced in this range will match exactly the colours reproduced in this brochure.



BIRTLEY		County Durham
Product Code	Product	Colour & Page
A2623A	Townhouse Blend	35
A2613A	Warwickshire Olde English	35
C2613A	Warwickshire Olde English 73mm	35
A2605A	Birtley Olde English Buff	48
A2630A	Millhouse Blend	54
A2618A	Northern Buff	48
A2634A	Birtley Brown Waterstruck	59
A2640A	Birtley Olde English Grey	62

CATTYBROOK		Avon
Product Code	Product	Colour & Page
A0661A	Bridgwater Weathered Red	29
A0655A	Bristol Mixed Red	22
A0656A	Bristol Orange Blend	22
A0630A	Bristol Red	13
A0635A	Brunswick Antique Red	28
A0636A	Brunswick Farmhouse Mixture	29
A0652A	Brunswick Multi Orange	25
A0637A	Brunswick Red	16
A0610A	Cheddar Red	13
A0647A	Severn Multi Red Blend	32
A0662A	Westbrick Red Purple Multi	25
A0657A	Bristol Buff Multi	53
A0634A	Bristol Gold	45
A0638A	Brunswick Autumn	46
A0640A	Brunswick Buff	47
A0643A	Brunswick Wilton Yellow	47
A0611A	Cheddar Golden	45
A0627A	Lansdown Multi Gold	46
A0620A	Tradesman Millgate Buff	54
A0628A	Bristol Brown	57
A0612A	Cheddar Brown	57
A0642A	Brunswick Tryfan Grey	61

CHAILEY		East Sussex
Product Code	Product	Colour & Page
A4517A	Hamsey Mixed Stock	38
A4514A	New Chailey Rustic Stock	41
A4501A	New Chailey Stock	41
A4527A	Cooksbridge Rustic Blend	49
A4512A	Cooksbridge Yellow Clamp Stock	49

CHESTERTON		Staffordshire
Product Code	Product	Colour & Page
A2947A	Alderley Burgundy	27
A2977A	Alderley Cottage Blend	27
A2948A	Alderley Mixture	28
A2946A	Alderley Orange	16
A2978A	Alderley Russet Blend	28
A2964A	Colonsay Red Rustic	14
A2905A	Etruria Mixture	23
A2965A	Grampian Red	16
A2967A	Grampian Red Mixture	30
A2922A	Hanchurch Mixture	23
A2916A	Hollington Blend	13
A2933A	Manorial Mixture	25
A2902A	Manorial Red	14
A2919A	Mercia Antique	31
A2974A	Mercia Orange	31
A2976A	Mercia Orange Multi	31
A2934A	Multi Red Smooth	21
A2912A	Etruscan	57

DORKET HEAD		Nottinghamshire
Product Code	Product	Colour & Page
A2405A	Balmoral	26
A2431A	Cavendish Dorket Fireglow	25
A2435A	Lenton Dark Multi	30
A2478A	Oakham Blend	30
A2417A	Sherwood Blaze	30

DORKET HEAD		Nottinghamshire
Product Code	Product	Colour & Page
A2426A	Welbeck Autumn Antique	30
A2423A	Welbeck Red Mixture	30
A2413A	Welbeck Village Blend	31
A2407A	Windsor	27
A2434A	Cavendish Dorket Honeygold	46
A2457A	Lenton Cream Multi	53
A2428A	Minster Beckstone Mixture	47
A2419A	Minster Cream Blend	47
A2418A	Minster Sandstone Mixture	48
A2458A	Lenton Golden Russet	53
A2406A	Sandringham	53

ECLIPSE		Leicestershire
Product Code	Product	Colour & Page
A0825A	Ivanhoe Westminster	39
A0812A	Leicester Multi Red Stock	40
A0802A	Leicester Red Stock	18
A0813A	Leicester Weathered Red	40
A0805A	New Ivanhoe Cream	55

ELLISTOWN		Leicestershire
Product Code	Product	Colour & Page
A4985A	Arden Olde Farmhouse Original	43
A4980A	Arden Red	17
A4982A	Arden Weathered Red	34
A4941A	Dorset Multi Red Stock	38
A4932A	Dorset Red Stock	17
A4989A	Heritage County Blend	17
A4986A	Heritage Red Blend	17
A4937A	Leicester Autumn Multi	39
A4946A	Leicester Orange Stock	17
A4935A	Leicester Weathered Multi	40
A4947A	Rustique Blend	42

Stockist's top tip: Mix loads of different products from the following pairs of factories: Aldridge/Atlas; Aldridge/Lodge Lane; Atlas/Lodge Lane; Chailey/West Hoathly; Chesterton/Parkhouse; Laybrook/South Holmwood; Throckley/Birtley; West Hoathly/Laybrook. Charges may apply for this service.

The product photographs represent as accurately as possible, within the limitations of photography and printing, the colour of a representative sample of this range of products. However Istock Brick does not warrant that all bricks produced in this range will match exactly the colours reproduced in this brochure.



# FACTORY INDEX

96

BRICK SELECTOR 2019 FACTORY INDEX

ELLISTOWN		Leicestershire
Product Code	Product	Colour & Page
A4977A	Heritage Light Red Multi	39
A4979A	Arden Grey	62
A4990A	Arden Weathered Grey	62
A4978A	Leicester Grey Stock	62
A4933A	Leicester Weathered Grey Stock	62

EXCLUSIVES RANGE		
A5149A	Continental Buff	45
A5143A	New Diana	45
A5145A	White Engobe	45
A5146A	Dark Grey	61
A5147A	Light Grey	61
A5144A	Black Smooth	65
A5051A	Brunel Smooth Blue Solid	67
A5050A	Brunel Smooth Blue Perforated	68

LAYBROOK		West Sussex
A0771A	Berkshire Orange Stock	17
A0717A	Capital Multi Stock	39
A0767A	Cissbury Red Multi Stock	38
K0773A	Laybrook Flame Red Stock Paver	74
E0756A	Laybrook Imperial Red Stock 68mm	17
A0772A	Multi Orange Stock	41
A0732A	Parham Light Multi Stock	41
A0700A	Petworth Multi Stock	42
M0727A	Red Multi Stock Paver	74
MN0773A	Suds Flame Red Stock Paver	74
MN0726A	Suds Multi Stock Paver	75
MN0727A	Suds Red Multi Stock Paver	75
A0709A	Thakeham Red Multi Stock	42
A0713A	Arundel Yellow Multi Stock	49
A0730A	Sevenoaks Yellow Stock	51
A0714A	Capital Brown Multi Stock	59

LEICESTER		Leicestershire
Product Code	Product	Colour & Page
A0031A	Bradgate Claret	36
A0020A	Bradgate Red	17
A0021A	Bradgate Regal	36
A0176A	Grosvenor Autumn Flame	36
A0149A	Grosvenor County Mixture	37
A0060A	Ivanhoe Antique	37
A0055A	Ivanhoe Cottage Blend	37
A0059A	Ivanhoe Katrina Multi	37
A0058A	Ivanhoe Mellow Red	37
A0062A	Ivanhoe Olde Village	37
A0103A	Amato Blend	54
A0023A	Bradgate Golden Purple	48
A0028A	Bradgate Harvest Antique	48
A0025A	Bradgate Light Buff	49
A0030A	Bradgate Multi Cream	49
A0102A	Dinian Blend	55
A0104A	Floriana Blend	55
A0167A	Gault Cream Stock	50
A0061A	Ivanhoe Athena Blend	55
A0054A	Ivanhoe Cream Original	55
A0189A	Leicester Multi Cream Stock	51
A0185A	Leicester Multi Yellow Stock	51
A0166A	Southwark Multi Stock	51
A0165A	Southwark Yellow Stock	51
A0032A	Bradgate Medium Grey	62
A0101A	Bruges Blend	62

LODGE LANE		Staffordshire
A2249A	Atlas Smooth Blue	67
A2221A	Staffordshire Blue Brindle Dragface	68
A2220A	Staffordshire Blue Brindle Smooth	68
A2232A	Staffordshire Slate Blue Smooth	68
C2232A	Staffordshire Slate Blue Smooth 73mm	68

NOSTELL		Leicestershire
Product Code	Product	Colour & Page
A0526A	Deva Red	13
A0578A	Melton Antique Blend	25
A0573A	Melton Blend	25
A0584A	Priory Red	21
A0589A	Priory Red Multi	22
A0585A	Priory Weathered Red	22
A0537A	Argyll Buff Multi Rustic	53
A0539A	Argyll Buff Wirecut	45
A0565A	Harewood Russet Buff	45
A0517A	Royston Golden Buff	46

PARKHOUSE		Staffordshire
A3022A	Audley Red Mixture Stock	37
A3058A	Betley Cottage Blend	38
A3025A	Mellow Ashridge Stock	40
A3010A	Mellow Regent Stock	18
A3018A	New Cavendish Stock	41
A3057A	New Sandhurst Stock	41
A3055A	Weston Red Multi Stock	43
A3035A	Lambourn Orange Multi Stock	39
A3016A	Marlborough Stock	50

RAVENHEAD		Lancashire
A3577A	Calderstone Claret	22
A3578A	Calderstone Russett	23
A3541A	Cheshire Weathered	34
A3596A	Chester Red Blend	21
A3516A	Hearted Red Rustic	23
A3527A	Oakleigh Red Blend	31
A3532A	Oldcott Rustic	24
A3518A	Ormonde Antique Blend	32
C3594A	Pre war common 73mm	21
A3502A	Ravenhead Red Rustic	14
A3501A	Ravenhead Red Smooth	13
C3501A	Ravenhead Red Smooth 73mm	13
A3579A	Roughdales Red Multi Rustic	25

Stockist's top tip: Mix loads of different products from the following pairs of factories: Aldridge/Atlas; Aldridge/Lodge Lane; Atlas/Lodge Lane; Chailey/West Hoathly; Chesterton/Parkhouse; Laybrook/South Holmwood; Throckley/Birtley; West Hoathly/Laybrook. Charges may apply for this service.

The product photographs represent as accurately as possible, within the limitations of photography and printing, the colour of a representative sample of this range of products. However Ibstock Brick does not warrant that all bricks produced in this range will match exactly the colours reproduced in this brochure.



RAVENHEAD		Lancashire
Product Code	Product	Colour & Page
A3598A	Tradesman® Common	22
A3542A	Tradesman® Light Rustic Blend	33
A3509A	Worsley Weathered	33
A3576A	Trafford Multi Rustic	53
A3505A	Bracken Brown Rustic	57
A3536A	Smooth Village Mixture	57

SCOTTISH DISTRIBUTION CENTRE		Lanarkshire
Product Code	Product	Colour & Page
A2964A	Colonsay Red Rustic	14
A2965A	Grampian Red	16
A2967A	Grampian Red Mixture	30
A2767A	Kilcreggan Multi Wirecut	23
A2703A	Mixed Red Textured	14
A2724A	Throckley Old English	24
A2702A	Throckley Red Rustic	15
A0537A	Argyll Buff Multi Rustic	53
A0539A	Argyll Buff Wirecut	45
A0643A	Brunswick Wilton Yellow	47
A2708A	Hadrian Buff	47
A0565A	Harewood Russet Buff	45
A2760A	Mixed Buff Rustic	46
A2715A	Oatmeal Textured	46
A2731A	Sandalwood	46
A3505A	Bracken Brown Rustic	57
A2912A	Etruscan	57

SOUTH HOLMWOOD		Surrey
Product Code	Product	Colour & Page
A4102A	Dorking Multi	26
A4125A	Dorking Red	15
A4157A	Holmwood Natural	16
A4145A	Reigate Medium Multi	26
A4148A	Reigate Purple	26
A4132A	Surrey County Red	32
A4143A	Surrey Light Multi	33
A4131A	Surrey Orange	16

SOUTH HOLMWOOD		Surrey
Product Code	Product	Colour & Page
A4133A	Surrey Red Multi	32
A4136A	Surrey Russet	33
A4138A	Surrey Cream Multi	48
A4156A	Surrey Yellow Multi	54
A4119A	Holbrook Sandfaced Brown	58
A4149A	Holbrook Sandfaced Black	65
A4120A	Holbrook Sandfaced Dark	65

SWANAGE		Dorset
Product Code	Product	Colour & Page
A4301A	Swanage Handmade Heather Red	19
B4301A	Swanage Handmade Heather Red 50mm	19
A4302A	Swanage Handmade Light Red	19
B4302A	Swanage Handmade Light Red 50mm	19
A4303A	Swanage Handmade Light Red Multi	43
B4303A	Swanage Handmade Light Red Multi 50mm	43
A4312A	Swanage Handmade Restoration Red	19
B4312A	Swanage Handmade Restoration Red 50mm	19
A4355A	Kingston Handmade Heather Red	19
R4355A	Kingston Handmade Heather Red Imperial	19
A4357A	Kingston Handmade Light Red	19
R4357A	Kingston Handmade Light Red Imperial	19
A4356A	Kingston Handmade Light Red Multi	43
R4356A	Kingston Handmade Light Red Multi Imperial	43
A4354A	Kingston Handmade Restoration Red	19
R4354A	Kingston Handmade Restoration Red Imperial	19
E4317A	Swanage Imperial Light Stock 68mm	18
E4316A	Swanage Imperial Red Stock 68mm	18

THROCKLEY		Tyne & Wear
Product Code	Product	Colour & Page
A2801A	Alnwick Blend	28
C2764A	Callerton Weathered Red 73mm	21
A2802A	Chillingham Blend	29
A2769A	Grainger Antique	29
A2770A	Grainger Autumn	29
A2709A	Hadrian Red	16

THROCKLEY		Tyne & Wear
Product Code	Product	Colour & Page
A2767A	Kilcreggan Multi Wirecut	23
A2703A	Mixed Red Textured	14
A2804A	Morpeth Blend	31
A2724A	Throckley Old English	24
A2702A	Throckley Red Rustic	15
A2730A	Throckley Smooth Red	13
A2701A	Tyne Red Bark	15
A2800A	Wylam Olde Blend	25
A2803A	Dilston Blend	53
A2771A	Grainger Gold	53
A2708A	Hadrian Buff	47
A2760A	Mixed Buff Rustic	46
A2715A	Oatmeal Textured	46
A2731A	Sandalwood	46
A2712A	Smooth Buff	45
A2738A	Stuart Buff	46
A2775A	Milburn Ashen Brown Blend	58
A2785A	Royston Silver Grey	61

WEST HOATHLY		Tyne & Wear
Product Code	Product	Colour & Page
A0778A	Sussex Blend	42
A0731A	West Hoathly Medium Multi Stock	40
A0736A	West Hoathly Sharpthorne Mixture Stock	42
A0750A	Kingscote Grey Multi	62

MADE THROUGHOUT THE COUNTRY		
Product Code	Product	Colour & Page
FHTH55	Anthracite Blue/Grey	93
FHTH35	Ash Grey	93
FH4520	Bevern Dark Multi Stock	93
FHTH65	Charcoal Black	93
FH4120	Holbrook Sandfaced Dark	93
FH0708	Parham Red Stock-Glazed Header	93
FH4041	Tonbridge Handmade Grey Brown	93
FH4302	Swanage Handmade Light Red-Glazed Header	93

Stockist's top tip: Mix loads of different products from the following pairs of factories: Aldridge/Atlas; Aldridge/Lodge Lane; Atlas/Lodge Lane; Chailey/West Hoathly; Chesterton/Parkhouse; Laybrook/South Holmwood; Throckley/Birtley; West Hoathly/Laybrook. Charges may apply for this service.

The product photographs represent as accurately as possible, within the limitations of photography and printing, the colour of a representative sample of this range of products. However Istock Brick does not warrant that all bricks produced in this range will match exactly the colours reproduced in this brochure.



# INDEX & TECHNICAL DATA

Product Code	Product Name	Factory	Page	Durability	Active Soluble Salts	Compressive Strength N/mm <sup>2</sup> (±)	Water Absorption % (S)	Size Tolerance Mean & Range	Pack Quantity	Maximum Load Size <sup>4</sup>	Brick Height mm	Dry Brick Weight Kg	Shrink-wrap	Palletised
A				BS EN771-1	BS EN771-1	BS EN771-1	BS EN771-1	BS EN771-1						
A2947A	Alderley Burgundy	Chesterton	27	F2	S2	60	10	T2 R1	500	10,500	65	2.4	Yes	*
A2977A	Alderley Cottage Blend	Chesterton	27	F2	S2	60	7	T2 R1	500	10,500	65	2.5	Yes	*
A2948A	Alderley Mixture	Chesterton	28	F2	S2	60	10	T2 R1	500	10,500	65	2.4	Yes	*
A2946A	Alderley Orange	Chesterton	16	F2	S2	60	10	T2 R1	500	10,500	65	2.4	Yes	*
A2978A	Alderley Russet Blend	Chesterton	28	F2	S2	60	7	T2 R1	500	10,500	65	2.5	Yes	*
A0270A	Aldridge Multi Rustic	Aldridge	26	F2	S2	35	12	T2 R1	316	10,112	65	2.1	*	*
C0270A	Aldridge Multi Rustic 73mm	Aldridge	26	F2	S2	35	12	T2 R1	292	9,344	73	2.5	*	*
A0376A	Aldridge Smooth Red	Atlas	13	F2	S2	60	9	T2 R1	400	11,200	65	2.4	*	*
C0376A	Aldridge Smooth Red 73 mm	Atlas	13	F2	S2	60	9	T2 R1	336	9,408	73	2.8	*	*
A2801A	Alnwick Blend	Throckley	28	F2	S2	60	10	T2 R1	500	12,000	65	2.3	Yes	*
A0103A	Amato Blend	Leicester	54	F2	S2	15	25	T2 R1	430	12,040	65	2	Top	*
A0258A	Anglian Beacon Sahara	Aldridge	46	F2	S2	45	12	T2 R1	316	10,112	65	2.1	*	*
C0258A	Anglian Beacon Sahara 73mm	Aldridge	46	F2	S2	45	12	T2 R1	292	9,344	73	2.3	*	*
A0353A	Anglian Buff Multi Rustic	Aldridge	46	F2	S2	45	12	T2 R1	316	10,112	65	2.1	*	*
C0353A	Anglian Buff Multi Rustic 73mm	Aldridge	46	F2	S2	45	12	T2 R1	292	9,344	73	2.3	*	*
A0257A	Anglian Red Multi Rustic	Aldridge	25	F1	S2	25	13	T2 R1	316	10,112	65	2.1	*	*
C0257A	Anglian Red Multi Rustic 73mm	Aldridge	25	F1	S2	25	13	T2 R1	292	9,344	73	2.3	*	*
A0352A	Anglian Red Rustic	Aldridge	14	F1	S2	25	13	T2 R1	316	10,112	65	2.1	*	*
C0352A	Anglian Red Rustic 73mm	Aldridge	14	F1	S2	25	13	T2 R1	292	9,344	73	2.3	*	*
C0356A	Anglian Ruskin Multi 73mm	Aldridge	25	F2	S2	35	12	T2 R1	292	9,344	73	2.5	*	*
A4979A	Arden Grey	Ellistown	62	F2	S2	20	22	T2 R1	500	13,500	65	2.3	Yes	*
A4985A	Arden Olde Farmhouse Original	Ellistown	43	F2	S2	20	19	T2 R1	500	12,500	65	2.2	Yes	*
A4980A	Arden Red	Ellistown	17	F2	S2	20	19	T2 R1	500	12,500	65	2.2	Yes	*
A4990A	Arden Weathered Grey	Ellistown	62	F2	S2	20	22	T2 R1	500	13,500	65	2.3	Yes	*
A4982A	Arden Weathered Red	Ellistown	34	F2	S2	20	19	T2 R1	500	12,500	65	2.2	Yes	*
A0537A	Argyll Buff Multi Rustic	Nostell	53	F2	S2	60	8	T2 R1	400	11,600	65	2.3	Yes	*
A0539A	Argyll Buff Wirecut	Nostell	45	F2	S2	60	8	T2 R1	400	11,600	65	2.1	Yes	*
A0713A	Arundel Yellow Multi Stock	Laybrook	49	F2	S2	25	14	Tm Rm	475	11,875	65	2.3	*	*
A0378A	Aston Red Sandfaced	Atlas	15	F2	S2	60	9	T2 R1	400	11,200	65	2.4	*	*
C0378A	Aston Red Sandfaced 73mm	Atlas	15	F2	S2	60	9	T2 R1	336	9,408	73	2.8	*	*
A2249A	Atlas Smooth Blue	Lodge Lane	67	F2	S2	75	7	T2 R1	380	12,160	65	2.4	*	*
A0300A	Atlas Smooth Red	Atlas	13	F2	S2	60	9	T2 R1	400	11,200	65	2.4	*	*
C0300A	Atlas Smooth Red 73 mm	Atlas	13	F2	S2	60	9	T2 R1	336	9,408	73	2.8	*	*
A3022A	Audley Red Mixture Stock	Parkhouse	37	F2	S2	15	13	T2 R1	500	10,500	65	2.5	*	*
B														
A2405A	Balmoral	Dorket Head	26	F2	S2	40	16	T2 R1	475	13,300	65	2.1	Yes	*
A2601A	Beamish Blend	Birtley	34	F2	S2	20	12	Tm Rm	392	10,976	65	2.7	Yes	*
C2601A	Beamish Blend 73mm	Birtley	34	F2	S2	20	12	Tm Rm	328	9,184	73	3.2	Yes	*
A0771A	Berkshire Orange Stock	Laybrook	17	F2	S2	25	14	Tm Rm	475	11,875	65	2.3	*	*
A3058A	Betley Cottage Blend	Parkhouse	38	F2	S2	15	13	T2 R1	500	10,500	65	2.5	*	*
A4009A	Bexhill Dark	Ashdown	38	F2	S2	30	15	T1 R1	500	12,500	65	2.3	*	*
A4033A	Bexhill Purple Multi	Ashdown	38	F2	S2	30	15	T1 R1	500	12,500	65	2.3	*	*
A4010A	Bexhill Red	Ashdown	38	F2	S2	30	15	T1 R1	500	12,500	65	2.3	*	*
A2634A	Birtley Brown	Birtley	59	F2	S2	20	12	Tm Rm	392	10,976	65	2.7	Yes	*
A2602A	Birtley Olde English	Birtley	34	F2	S2	20	12	Tm Rm	392	10,976	65	2.7	Yes	*
C2602A	Birtley Olde English 73mm	Birtley	34	F2	S2	20	12	Tm Rm	328	9,184	73	3.2	Yes	*
A2605A	Birtley Olde English Buff	Birtley	48	F2	S2	20	12	Tm Rm	392	10,976	65	2.7	Yes	*
A5144A	Black Smooth	Imports	65	F2	S2	40	6	T2 R2	468	+	65	2.5	+	+
A2631A	Borrowdale Blend	Birtley	34	F2	S2	20	12	Tm Rm	406	10,976	65	2.7	Yes	*
C2631A	Borrowdale Blend 73mm	Birtley	34	F2	S2	20	12	Tm Rm	328	9,184	73	3.2	Yes	*
A3505A	Bracken Brown Rustic	Ravenhead	57	F2	S2	60	9	T2 R1	404	12,500	65	2.3	+	+
A0031A	Bradgate Claret	Leicester	36	F2	S2	20	19	T2 R1	430	12,040	65	2.1	Top	*
A0023A	Bradgate Golden Purple	Leicester	48	F2	S2	20	20	T2 R1	430	14,190	65	2	Top	*
A0028A	Bradgate Harvest Antique	Leicester	48	F2	S2	20	20	T2 R1	430	14,190	65	2	Top	*
A0025A	Bradgate Light Buff	Leicester	49	F2	S2	15	25	T2 R1	430	14,190	65	2	Top	*
A0032A	Bradgate Medium Grey	Leicester	62	F2	S2	20	20	T2 R1	430	14,190	65	2	Top	*
A0030A	Bradgate Multi Cream	Leicester	49	F2	S2	15	25	T2 R1	430	14,190	65	2	Top	*



Product Code	Product Name	Factory	Page	Durability	Active Soluble Salts	Compressive Strength N/mm <sup>2</sup> (z)	Water Absorption % (s)	Size Tolerance Mean & Range		Pock Quantity	Maximum Load Size <sup>▲</sup>	Brick Height mm	Dry Brick Weight Kg	Shrink-wrap	Palletised
								BS EN771-1	BS EN771-1						
<b>B</b>															
A0020A	Bradgate Red	Leicester	17	F2	S2	20	19	T2	R1	430	12,470	65	2.1	Top	*
A0021A	Bradgate Regal	Leicester	36	F2	S2	20	19	T2	R1	430	12,470	65	2.1	Top	*
A0661A	Bridgwater Weathered Red	Cattybrook	29	F2	S2	50	10	T2	R1	500	11,000	65	2.4	*	*
A0628A	Bristol Brown	Cattybrook	57	F2	S2	50	10	T2	R1	500	11,000	65	2.4	*	*
A0657A	Bristol Buff Multi	Cattybrook	53	F2	S2	50	12	T2	R1	500	11,000	65	2.3	*	*
A0634A	Bristol Gold	Cattybrook	45	F2	S2	50	12	T2	R1	500	11,000	65	2.2	*	*
A0655A	Bristol Mixed Red	Cattybrook	22	F2	S2	50	10	T2	R1	500	11,000	65	2.4	*	*
A0656A	Bristol Orange Blend	Cattybrook	22	F2	S2	50	10	T2	R1	500	11,000	65	2.4	*	*
A0630A	Bristol Red	Cattybrook	13	F2	S2	50	10	T2	R1	500	11,000	65	2.4	*	*
A0260A	Brown Blend	Aldridge	57	F2	S2	35	12	T2	R1	316	10,112	65	2.1	*	*
A0101A	Bruges Blend	Leicester	62	F2	S2	15	25	T2	R1	430	12,040	65	2	Top	*
A5050A	Brunel Smooth Blue	Imports	68	F2	S2	75	6	T2	R1	416	+	65	2.5	Yes	Yes
A5051A	Brunel Smooth Blue Solid	Imports	67	F2	S2	75	6	T2	R1	416	+	65	3.3	Yes	Yes
A0635A	Brunswick Antique Red	Cattybrook	28	F2	S2	50	10	T2	R1	500	11,000	65	2.4	*	*
A0638A	Brunswick Autumn	Cattybrook	46	F2	S2	50	12	T2	R1	500	11,000	65	2.3	*	*
A0640A	Brunswick Buff	Cattybrook	47	F2	S2	50	12	T2	R1	500	11,000	65	2.3	*	*
A0636A	Brunswick Farmhouse Mixture	Cattybrook	29	F2	S2	50	10	T2	R1	500	11,000	65	2.4	*	*
A0652A	Brunswick Multi Orange	Cattybrook	25	F2	S2	50	10	T2	R1	500	11,000	65	2.4	*	*
A0637A	Brunswick Red	Cattybrook	16	F2	S2	50	10	T2	R1	500	11,000	65	2.4	*	*
A0642A	Brunswick Tryfan Grey	Cattybrook	61	F2	S2	50	12	T2	R1	500	11,000	65	2.3	*	*
A0643A	Brunswick Wilton Yellow	Cattybrook	47	F2	S2	50	12	T2	R1	500	11,000	65	2.3	*	*
<b>C</b>															
A3577A	Calderstone Claret	Ravenhead	22	F2	S2	60	9	T2	R1	404	12,500	65	2.3	+	+
A3578A	Calderstone Russett	Ravenhead	23	F2	S2	60	9	T2	R1	404	12,500	65	2.3	+	+
A0390A	Caledonian Buff Blend	Atlas	53	F2	S2	45	9	T2	R1	400	11,200	65	2.2	*	*
C2764A	Callerton Weathered Red 73mm	Throckley	21	F2	S2	60	10	T2	R1	424	10,176	73	2.7	Yes	*
A0714A	Capital Brown Multi Stock	Laybrook	59	F2	S2	25	14	Tm	Rm	475	11,875	65	2.3	*	*
A0717A	Capital Multi Stock	Laybrook	39	F2	S2	25	14	Tm	Rm	475	12,350	65	2.3	*	*
A2431A	Cavendish Dorket Fireglow	Dorket Head	25	F1	S2	40	16	T2	R1	475	13,300	65	2	Yes	*
A2434A	Cavendish Dorket Honeygold	Dorket Head	46	F1	S2	40	16	T2	R1	475	13,300	65	2.1	Yes	*
A0612A	Cheddar Brown	Cattybrook	57	F2	S2	50	10	T2	R1	500	11,000	65	2.4	Yes	*
A0611A	Cheddar Golden	Cattybrook	45	F2	S2	50	12	T2	R1	500	10,500	65	2.3	Yes	*
A0610A	Cheddar Red	Cattybrook	13	F2	S2	75	7	T2	R1	500	10,000	65	2.5	Yes	*
A3541A	Cheshire Weathered	Ravenhead	21	F2	S2	50	12	T2	R1	404	+	65	2.2	+	+
C3541A	Cheshire Weathered 73mm	Ravenhead	21	F2	S2	50	12	T2	R1	376	+	73	2.6	+	+
A3596A	Chester Red Blend	Ravenhead	21	F2	S2	60	9	T2	R1	404	12,500	65	2.3	+	+
A2802A	Chillingham Blend	Throckley	29	F2	S2	60	10	T2	R1	500	12,000	65	2.3	Yes	*
A0767A	Cissbury Red Multi Stock	Laybrook	38	F2	S2	25	14	Tm	Rm	475	11,875	65	2.3	*	*
A4027A	Coleridge Yellow Multi	Ashdown	49	F2	S2	30	15	T1	R1	500	12,500	65	2.3	*	*
A2964A	Colonsay Red Rustic	Chesterton	14	F2	S2	60	7	T2	R1	500	10,500	65	2.5	Yes	*
A2611A	Commercial Red	Birtley	34	F2	S2	20	12	Tm	Rm	392	10,976	65	2.7	Yes	*
C2611A	Commercial Red 73mm	Birtley	34	F2	S2	20	12	Tm	Rm	328	9,184	73	3.2	Yes	*
A5149A	Continental Buff	Imports	45	F2	S2	40	6	T2	R2	468	+	65	2.4	Yes	Yes
A4512A	Cooksbridge Yellow Clamp Stock	Chailey	49	F2	S2	12	12	T1	R1	370	12,580	65	2.1	*	*
A4001A	Cottage Mixture	Ashdown	38	F2	S2	30	15	T1	R1	500	12,500	65	2.3	*	*
A4002A	Crowborough Multicoloured Stock	Ashdown	62	F2	S2	30	15	T1	R1	500	11,000	65	2.3	*	*
A2629A	Cumberland Blend	Birtley	34	F2	S2	20	12	Tm	Rm	392	10,976	65	2.7	Yes	*
<b>D</b>															
A5146A	Dark Grey	Imports	61	F2	S2	40	6	T2	R2	468	+	65	2.4	Yes	Yes
A0526A	Deva Red	Nostell	13	F2	S2	60	10	T2	R1	400	11,600	65	2.1	*	*
A2803A	Dilston Blend	Throckley	53	F2	S2	60	10	T2	R1	500	12,000	65	2.3	Yes	*
A0102A	Dinian Blend	Leicester	55	F2	S2	15	25	T2	R1	430	12,040	65	2	Top	*
A4102A	Dorking Multi	South Holmwood	26	F2	S2	40	12	T2	R1	500	14,500	65	2.1	*	*
A4125A	Dorking Red	South Holmwood	15	F2	S2	40	12	T2	R1	500	14,000	65	2.1	*	*
A4941A	Dorset Multi Red Stock	Ellistown	38	F2	S2	20	19	T2	R1	500	12,500	65	2.2	Yes	*
A4932A	Dorset Red Stock	Ellistown	17	F2	S2	20	19	T2	R1	500	12,500	65	2.2	Yes	*



# INDEX & TECHNICAL DATA

100

BRICK SELECTOR 2019 INDEX & TECHNICAL DATA

Product Code	Product Name	Factory	Page	Durability	Active Soluble Salts	Compressive Strength N/mm <sup>2</sup> (±)	Water Absorption % (S)	Size Tolerance Mean & Range	Pack Quantity	Maximum Load Size 4	Brick Height mm	Dry Brick Weight Kg	Shrink-wrap	Palletised
<b>E</b>														
				BS EN771-1	BS EN771-1	BS EN771-1	BS EN771-1	BS EN771-1						
A0100A	Earlwood Textured Buff	Atlas	45	F2	S2	45	9	T2 R1	400	11,200	65	2.2	*	*
A2905A	Etruria Mixture	Chesterton	23	F2	S2	60	7	T2 R1	500	10,500	65	2.5	*	*
A2912A	Etruscan	Chesterton	57	F2	S2	60	7	T2 R1	500	10,500	65	2.5	Yes	*
<b>F</b>														
A0104A	Floriana Blend	Leicester	55	F2	S2	15	25	T2 R1	430	12,040	65	2	Top	*
A4053A	Funton Old Chelsea Yellow	Ashdown	49	F2	S2	12	21	Tm Rm	500	11,500	65	2.1	*	*
D4053A	Funton Old Chelsea Yellow Imperial	Ashdown	49	F2	S2	12	23	Tm Rm	480	9,600	68	2.5	Yes	Yes
A4049A	Funton Harvest Mixture	Ashdown	50	F2	S2	12	21	Tm Rm	500	11,500	65	2.1	Yes	Yes
A4050A	Funton Second Hard Stock	Ashdown	50	F2	S2	12	21	Tm Rm	500	11,500	65	2.1	Yes	Yes
<b>G</b>														
A0167A	Gault Cream Stock	Leicester	50	F2	S2	15	25	T2 R1	430	14,190	65	2	Top	*
A0266A	Georgian Red Blend	Aldridge	25	F2	S2	35	12	T2 R1	316	10,112	65	2.1	*	*
A2769A	Grainger Antique	Throckley	29	F2	S2	60	10	T2 R1	500	12,000	65	2.3	Yes	*
A2770A	Grainger Autumn	Throckley	29	F2	S2	60	10	T2 R1	500	12,000	65	2.3	Yes	*
A2771A	Grainger Gold	Throckley	53	F2	S2	50	9	T2 R1	500	12,000	65	2.3	Yes	*
A2965A	Grampian Red	Chesterton	16	F2	S2	60	7	T2 R1	500	10,500	65	2.5	Yes	*
A2967A	Grampian Red Mixture	Chesterton	30	F2	S2	60	7	T2 R1	500	10,500	65	2.5	Yes	*
A0176A	Grosvenor Autumn Flame	Leicester	36	F2	S2	20	19	T2 R1	430	12,470	65	2.1	Top	*
A0149A	Grosvenor County Mixture	Leicester	37	F2	S2	20	19	T2 R1	430	12,470	65	2.1	Top	*
<b>H</b>														
A2708A	Hadrian Buff	Throckley	47	F2	S2	50	9	T2 R1	500	12,000	65	2.3	Yes	*
A2709A	Hadrian Red	Throckley	16	F2	S2	60	10	T2 R1	500	12,000	65	2.3	Yes	*
A4517A	Hamsey Mixed Stock	Chailey	38	F2	S2	12	12	T1 R1	370	12,580	65	2.1	*	*
A2922A	Hanchurch Mixture	Chesterton	23	F2	S2	60	7	T2 R1	500	10,500	65	2.5	*	*
A2457A	Hardwicke Lenton Cream Multi	Dorket Head	53	F2	S2	40	16	T2 R1	475	13,300	65	2.1	Yes	*
A2435A	Hardwicke Lenton Dark Multi	Dorket Head	30	F2	S2	40	16	T2 R1	475	13,300	65	2.1	Yes	*
A2458A	Hardwicke Lenton Golden Russet	Dorket Head	53	F2	S2	40	16	T2 R1	475	13,300	65	2.1	Yes	*
A2428A	Hardwicke Minster Beckstone Mixture	Dorket Head	47	F2	S2	40	16	T2 R1	475	13,300	65	2.1	Yes	*
A2419A	Hardwicke Minster Cream Blend	Dorket Head	47	F2	S2	40	16	T2 R1	475	13,300	65	2.1	Yes	*
A2418A	Hardwicke Minster Sandstone Mixture	Dorket Head	48	F2	S2	40	16	T2 R1	475	13,300	65	2.1	Yes	*
A2478A	Hardwicke Oakham Blend	Dorket Head	30	F2	S2	40	16	T2 R1	475	13,300	65	2.1	Yes	*
A2417A	Hardwicke Sherwood Blaze	Dorket Head	30	F2	S2	40	16	T2 R1	475	13,300	65	2.1	Yes	*
A2426A	Hardwicke Welbeck Autumn Antique	Dorket Head	30	F2	S2	40	16	T2 R1	475	13,300	65	2.1	Yes	*
A2423A	Hardwicke Welbeck Red Mixture	Dorket Head	30	F2	S2	40	16	T2 R1	475	13,300	65	2.1	Yes	*
A2413A	Hardwicke Welbeck Village Blend	Dorket Head	31	F2	S2	40	16	T2 R1	475	13,300	65	2.1	Yes	*
A0565A	Harewood Russet Buff	Nostell	45	F2	S2	60	8	T2 R1	400	11,600	65	2.1	*	*
A3516A	Hearted Red Rustic	Ravenhead	23	F2	S2	60	9	T2 R1	404	12,500	65	2.3	+	+
A4989A	Heritage County Blend	Ellistown	17	F2	S2	20	19	T2 R1	500	12,500	65	2.2	Yes	*
A4986A	Heritage Red Blend	Ellistown	17	F2	S2	20	19	T2 R1	500	12,500	65	2.2	Yes	*
A0358A	Himley Ash Grey	Aldridge	61	F2	S2	45	12	T2 R1	316	10,112	65	2.1	*	*
A0355A	Himley Dark Brown Rustic	Aldridge	57	F2	S2	40	12	T2 R1	316	10,112	65	2.2	*	*
A0354A	Himley Ebony Black	Aldridge	65	F2	S2	40	12	T2 R1	316	10,112	65	2.2	*	*
A0335A	Himley Mixed Russet Original	Atlas	23	F2	S2	60	9	T2 R1	400	11,200	65	2.4	*	*
A0317A	Himley Worcestershire Mixture	Atlas	31	F2	S2	60	9	T2 R1	400	11,200	65	2.4	*	*
A4149A	Holbrook Sandfaced Black	South Holmwood	65	F2	S2	40	12	T2 R1	500	13,500	65	2.1	Yes	*
A4119A	Holbrook Sandfaced Brown	South Holmwood	58	F2	S2	40	12	T2 R1	500	13,500	65	2.1	*	*
A4120A	Holbrook Sandfaced Dark	South Holmwood	65	F2	S2	40	12	T2 R1	500	12,500	65	2.1	*	*
A2916A	Hollington Blend	Chesterton	13	F2	S2	60	7	T2 R1	500	10,500	65	2.5	*	*
A4157A	Holmwood Natural	South Holmwood	16	F2	S2	40	12	T2 R1	500	14,000	65	2.1	Yes	*
<b>I</b>														
A0060A	Ivanhoe Antique	Leicester	37	F2	S2	20	19	T2 R1	430	12,470	65	2.1	Top	*
A0061A	Ivanhoe Athena Blend	Leicester	55	F2	S2	20	20	T2 R1	430	14,190	65	2	Top	*
A0055A	Ivanhoe Cottage Blend	Leicester	37	F2	S2	20	19	T2 R1	430	12,470	65	2.1	Top	*
A0054A	Ivanhoe Cream	Leicester	55	F2	S2	15	25	T2 R1	430	14,190	65	2	Top	*
A0059A	Ivanhoe Katrina Multi	Leicester	37	F2	S2	20	19	T2 R1	430	12,470	65	2.1	Top	*
A0058A	Ivanhoe Mellow Red	Leicester	37	F2	S2	20	19	T2 R1	430	12,040	65	2.1	Top	*
A0062A	Ivanhoe Olde Village	Leicester	37	F2	S2	20	19	T2 R1	430	12,470	65	2.1	Top	*



Product Code	Product Name	Factory	Page	Durability	Active Soluble Salts	Compressive Strength N/mm <sup>2</sup> (z)	Water Absorption % (s)	Size Tolerance Mean & Range		Pock Quantity	Maximum Load Size <sup>▲</sup>	Brick Height mm	Dry Brick Weight Kg	Shrink-wrap	Palletised
								BS EN771-1	BS EN771-1						
<b>K</b>															
A2767A	Kilcreggan Multi Wirecut	Throckley	23	F2	S2	60	10	T2	R1	500	12,000	65	2.3	Yes	*
A0750A	Kingscote Grey Multi	West Hoathly	62	F2	S2	20	12	T2	R1	500	11,000	65	2.3	*	*
A4355A	Kingston Handmade Heather Red	Swanage	19	F2	S2	15	13	T1	R1	476	9,520	65	2.9	Yes	Yes
R4355A	Kingston Handmade Heather Red Imperial	Swanage	19	F2	S2	15	13	T1	R1	420	8,400	68	2.9	Yes	Yes
A4357A	Kingston Handmade Light Red	Swanage	19	F2	S2	15	13	T1	R1	476	9,520	65	2.9	Yes	Yes
R4357A	Kingston Handmade Light Red Imperial	Swanage	19	F2	S2	15	13	T1	R1	420	8,400	68	2.9	Yes	Yes
A4356A	Kingston Handmade Light Red Multi	Swanage	43	F2	S2	15	13	T1	R1	476	9,520	65	2.9	Yes	Yes
R4356A	Kingston Handmade Light Red Multi Imperial	Swanage	43	F2	S2	15	13	T1	R1	420	8,400	68	2.9	Yes	Yes
A4354A	Kingston Handmade Restoration Red	Swanage	19	F2	S2	15	13	T1	R1	476	9,520	65	2.9	Yes	Yes
R4354A	Kingston Handmade Restoration Red Imperial	Swanage	19	F2	S2	15	13	T1	R1	420	8,400	68	2.9	Yes	Yes
<b>L</b>															
A3035A	Lambourn Orange Multi Stock	Parkhouse	39	F2	S2	15	13	T2	R1	500	10,500	65	2.5	*	*
A0627A	Lansdown Multi Gold	Cattybrook	46	F2	S2	50	12	T2	R1	500	11,000	65	2.3	*	*
E0756A	Laybrook Imperial Red Stock	Laybrook	17	F2	S2	20	19	T1	R1	430	9,030	68	2.7	*	*
A0772A	Laybrook Multi Orange Stock	Laybrook	41	F2	S2	25	14	Tm	Rm	475	11,400	65	2.3	*	*
A4937A	Leicester Autumn Multi	Ellistown	39	F2	S2	20	19	T2	R1	500	12,500	65	2.2	Yes	*
A4978A	Leicester Grey Stock	Ellistown	62	F2	S2	20	22	T2	R1	500	13,500	65	2.3	Yes	*
A0189A	Leicester Multi Cream Stock	Leicester	51	F2	S2	15	25	T2	R1	430	14,190	65	2	Top	*
A0812A	Leicester Multi Red Stock	Leicester	40	F2	S2	20	19	T2	R1	430	12,900	65	2.2	Top	*
A0185A	Leicester Multi Yellow Stock	Leicester	51	F2	S2	25	20	T2	R1	430	13,330	65	2	Top	*
A4946A	Leicester Orange Stock	Ellistown	17	F2	S2	20	19	T2	R1	500	12,500	65	2.2	Yes	*
A0802A	Leicester Red Stock	Ellistown	18	F2	S2	20	19	T2	R1	500	12,500	65	2.2	Yes	*
A4933A	Leicester Weathered Grey Stock	Ellistown	62	F2	S2	20	22	T2	R1	500	13,500	65	2.3	Yes	*
A4935A	Leicester Weathered Multi	Ellistown	40	F2	S2	20	19	T2	R1	500	12,500	65	2.2	Yes	*
A0813A	Leicester Weathered Red	Ellistown	40	F2	S2	20	19	T2	R1	500	12,500	65	2.2	Yes	*
A5147A	Light Grey	Imports	61	F2	S2	40	6	T2	R2	468	**	65	2	Yes	Yes
A4052A	London Reclaim Mixture	Ashdown	50	F2	S2	12	21	Tm	Rm	500	11,500	65	2.1	*	*
D4052A	London Reclaim Mixture Imperial	Ashdown	50	F2	S2	12	23	Tm	Rm	480	9,600	68	2.5	Yes	Yes
<b>M</b>															
A0350A	Madeley Mixture	Aldridge	24	F2	S2	40	12	T2	R1	316	10,112	65	2.2	*	*
C0350A	Madeley Mixture 73mm	Aldridge	24	F2	S2	40	12	T2	R1	292	9,344	73	2.7	*	*
A2933A	Manorial Mixture	Chesterton	25	F2	S2	60	7	T2	R1	500	10,500	65	2.5	*	*
A2902A	Manorial Red	Chesterton	14	F2	S2	60	7	T2	R1	500	10,500	65	2.5	*	*
A3016A	Marlborough Stock	Parkhouse	50	F2	S2	15	13	T2	R1	500	10,500	65	2.5	*	*
A3025A	Mellow Ashridge Stock	Parkhouse	40	F2	S2	15	13	T2	R1	500	10,500	65	2.5	*	*
A3010A	Mellow Regent Stock	Parkhouse	18	F2	S2	15	13	T2	R1	500	10,500	65	2.5	*	*
A0578A	Melton Antique Blend	Nostell	25	F2	S2	60	10	T2	R1	400	11,600	65	2.4	*	*
A0573A	Melton Blend	Nostell	25	F2	S2	60	10	T2	R1	400	11,600	65	2.4	*	*
A2919A	Mercia Antique	Chesterton	31	F2	S2	60	7	T2	R1	500	10,500	65	2.5	*	*
A2974A	Mercia Orange	Chesterton	31	F2	S2	60	7	T2	R1	500	10,500	65	2.5	*	*
A2976A	Mercia Orange Multi	Chesterton	31	F2	S2	60	7	T2	R1	500	10,500	65	2.5	*	*
A2775A	Milburn Ashen Brown Blend	Throckley	58	F2	S2	60	10	T2	R1	500	12,000	65	2.3	Yes	*
A2630A	Millhouse Blend	Birtley	54	F2	S2	20	12	Tm	Rm	392	10,976	65	2.7	Yes	*
A2760A	Mixed Buff Rustic	Throckley	46	F2	S2	50	9	T2	R1	500	12,000	65	2.2	Yes	*
A2703A	Mixed Red Textured	Throckley	14	F2	S2	60	10	T2	R1	500	12,000	65	2.3	Yes	*
A2804A	Morpeth Blend	Throckley	31	F2	S2	60	10	T2	R1	500	12,000	65	2.3	Yes	*
A0268A	Multi Grey Rustic	Aldridge	61	F2	S2	35	12	T2	R1	316	10,112	65	2.1	*	*
A2934A	Multi Red Smooth	Chesterton	21	F2	S2	60	7	T2	R1	500	10,500	65	2.5	Yes	*
<b>N</b>															
A0269A	New Burntwood Red Rustic	Aldridge	26	F2	S2	35	12	T2	R1	316	10,112	65	2.1	*	*
C0269A	New Burntwood Red Rustic 73mm	Aldridge	26	F2	S2	35	12	T2	R1	292	9,344	73	2.5	*	*
A3018A	New Cavendish Stock	Parkhouse	41	F2	S2	15	13	T2	R1	500	10,500	65	2.5	*	*
A4514A	New Chailey Rustic Stock	Chailey	41	F2	S2	12	12	T1	R1	370	12,580	65	2.1	*	*
A4501A	New Chailey Stock	Chailey	41	F2	S2	12	12	T1	R1	370	12,580	65	2.1	*	*
A5143A	New Diana	Imports	45	F2	S2	40	6	T2	R2	520	**	65	1.8	Yes	Yes
A3057A	New Sandhurst Stock	Parkhouse	41	F2	S2	15	13	T2	R1	500	10,500	65	2.5	*	*
A2618A	Northern Buff	Birtley	48	F2	S2	20	12	Tm	Rm	392	10,976	65	2.7	Yes	*
A2622A	Northumbrian Cottage	Birtley	34	F2	S2	20	12	Tm	Rm	406	10,976	65	2.7	Yes	*



# INDEX & TECHNICAL DATA

Product Code	Product Name	Factory	Page	Durability	Active Soluble Salts	Compressive Strength N/mm <sup>2</sup> (±)	Water Absorption % (S)	Size Tolerance Mean & Range	Pack Quantity	Maximum Load Size <sup>4</sup>	Brick Height mm	Dry Brick Weight Kg	Shrink-wrap	Palletised	
				BS EN771-1	BS EN771-1	BS EN771-1	BS EN771-1	BS EN771-1							
<b>O</b>															
A3527A	Oakleigh Red Blend	Ravenhead	31	F2	S2	60	9	T2 R1	404	12,500	65	2.3	+	+	
A2715A	Oatmeal Textured	Throckley	46	F2	S2	50	9	T2 R1	500	12,000	65	2.3	Yes	*	
A3532A	Oldcott Rustic	Ravenhead	24	F2	S2	50	12	T2 R1	404	12,500	65	2.2	+	+	
A2640A	Olde English Grey	Birtley	62	F2	S2	20	12	Tm Rm	406	10,976	65	2.6	Yes	*	
A3518A	Ormonde Antique Blend	Ravenhead	32	F2	S2	50	12	T2 R1	404	12,500	65	2.2	+	+	
A2621A	Otterburn Antique	Birtley	35	F2	S2	20	12	Tm Rm	392	10,976	65	2.7	Yes	*	
<b>P</b>															
A0732A	Parham Light Multi Stock	Laybrook	41	F2	S2	25	14	Tm Rm	475	11,400	65	2.3	*	*	
A0700A	Petworth Multi Stock	Laybrook	42	F2	S2	25	14	Tm Rm	475	11,875	65	2.3	*	*	
A4004A	Pevensey Multi Stock	Ashdown	42	F2	S2	30	15	T1 R1	500	12,500	65	2.3	*	*	
C3594A	Pre War Common	Ravenhead	21	F2	S2	50	12	T2 R1	424	11,024	73	2.6	+	+	
A0584A	Priory Red	Nostell	21	F2	S2	60	10	T2 R1	400	11,600	65	2.1	*	*	
A0589A	Priory Red Multi	Nostell	22	F2	S2	60	10	T2 R1	400	11,600	65	2.1	*	*	
A0585A	Priory Weathered Red	Nostell	22	F2	S2	60	10	T2 R1	400	11,600	65	2.1	*	*	
C0585A	Priory Weathered Red 73mm	Nostell	22	F2	S2	60	10	T2 R1	368	8,832	73	2.7	*	*	
<b>R</b>															
A3502A	Ravenhead Red Rustic	Ravenhead	14	F2	S2	60	9	T2 R1	404	12,500	65	2.3	+	+	
C3502A	Ravenhead Red Rustic 73mm	Ravenhead	14	F2	S2	60	9	T2 R1	376	11,024	73	2.6	+	+	
A3501A	Ravenhead Red Smooth	Ravenhead	13	F2	S2	60	9	T2 R1	404	12,500	65	2.3	+	+	
C3501A	Ravenhead Red Smooth 73mm	Ravenhead	13	F2	S2	60	9	T2 R1	376	11,024	73	2.6	+	+	
A4145A	Reigate Medium Multi	South Holmwood	26	F2	S2	40	12	T2 R1	500	14,500	65	2.1	*	*	
A4148A	Reigate Purple	South Holmwood	26	F2	S2	40	12	T2 R1	500	14,500	65	2.1	*	*	
A3579A	Roughdales Red Multi Rustic	Ravenhead	25	F2	S2	60	9	T2 R1	404	12,500	65	2.3	+	+	
C3579A	Roughdales Red Multi Rustic 73mm	Ravenhead	25	F2	S2	60	9	T2 R1	376	11,024	73	2.6	+	+	
A0517A	Royston Golden Buff	Nostell	46	F2	S2	60	8	T2 R1	400	11,600	65	2.1	*	*	
A2785A	Royston Silver Grey	Throckley	61	F2	S2	50	9	T2 R1	500	12,000	65	2.3	Yes	*	
C0256A	Ruskin Red 73mm	Aldridge	22	F2	S2	40	12	T2 R1	292	9,344	73	2.7	*	*	
A4947A	Rustique Blend	Ellistown	42	F2	S2	20	19	T2 R1	500	10,500	65	2.2	Yes	*	
<b>S</b>															
A2731A	Sandalwood	Throckley	46	F2	S2	50	9	T2 R1	500	12,000	65	2.3	Yes	*	
A2406A	Sandringham	Dorket Head	53	F2	S2	40	16	T2 R1	475	13,300	65	2.1	Yes	*	
A0730A	Sevenoaks Yellow Stock	Laybrook	51	F2	S2	25	19	Tm Rm	475	12,825	65	2.1	*	*	
A0647A	Severn Multi Red Blend	Cattybrook	32	F2	S2	50	10	T2 R1	500	11,000	65	2.4	*	*	
A0085A	Shireoak Russet	Aldridge	26	F2	S2	35	12	T2 R1	316	10,112	65	2.2	*	*	
A2712A	Smooth Buff	Throckley	45	F2	S2	50	9	T2 R1	500	12,000	65	2.2	Yes	*	
A3536A	Smooth Village Mixture	Ravenhead	57	F2	S2	50	12	T2 R1	404	12,500	65	2.3	+	+	
A0166A	Southwark Multi Stock	Leicester	51	F2	S2	25	20	T2 R1	430	13,330	65	2	Top	*	
A0165A	Southwark Yellow Stock	Leicester	51	F2	S2	25	20	T2 R1	430	13,330	65	2	Top	*	
A2221A	Staffordshire Blue Brindle Dragface	Lodge Lane	68	F2	S2	75	7	T2 R1	380	12,160	65	2.4	*	*	
A2220A	Staffordshire Blue Brindle Smooth	Lodge Lane	68	F2	S2	75	7	T2 R1	380	12,160	65	2.4	*	*	
A0287A	Staffordshire Georgian	Aldridge	26	F2	S2	35	12	T2 R1	316	10,112	65	2.1	*	*	
A0289A	Staffordshire Multi Rustic	Aldridge	26	F2	S2	35	12	T2 R1	316	10,112	65	2.1	*	*	
C0289A	Staffordshire Multi Rustic 73mm	Aldridge	26	F2	S2	35	12	T2 R1	292	9,344	73	2.5	*	*	
A2232A	Staffordshire Slate Blue Smooth	Lodge Lane	68	F2	S2	75	7	T2 R1	380	12,160	65	2.4	*	*	
C2232A	Staffordshire Slate Blue Smooth 73mm	Lodge Lane	68	F2	S2	75	7	T2 R1	340	10,880	73	3	*	*	
A0288A	Staffordshire Smooth	Aldridge	22	F2	S2	40	12	T2 R1	316	10,112	65	2.2	*	*	
C0288A	Staffordshire Smooth 73mm	Aldridge	22	F2	S2	40	12	T2 R1	292	9,344	73	2.7	*	*	
A0334A	Stratford Red Dragface	Atlas	14	F2	S2	60	9	T2 R1	400	11,200	65	2.4	*	*	
A0333A	Stratford Red Rustic	Atlas	14	F2	S2	60	9	T2 R1	400	11,200	65	2.4	*	*	
A2738A	Stuart Buff	Throckley	46	F2	S2	50	9	T2 R1	500	12,000	65	2.2	Yes	*	
A4132A	Surrey County Red	South Holmwood	32	F2	S2	40	12	T2 R1	500	14,000	65	2.1	*	*	
A4138A	Surrey Cream Multi	South Holmwood	48	F2	S2	40	20	T2 R1	500	15,000	65	1.7	Yes	*	
A4143A	Surrey Light Multi	South Holmwood	33	F2	S2	40	12	T2 R1	500	14,500	65	2.1	*	*	
A4131A	Surrey Orange	South Holmwood	16	F2	S2	40	12	T2 R1	500	14,000	65	2.1	*	*	
A4133A	Surrey Red Multi	South Holmwood	32	F2	S2	40	12	T2 R1	500	14,500	65	2.1	*	*	
A4136A	Surrey Russet	South Holmwood	33	F2	S2	40	12	T2 R1	500	14,000	65	2.1	*	*	
A4156A	Surrey Yellow Multi	South Holmwood	54	F2	S2	40	20	T2 R1	500	15,000	65	1.7	Yes	*	



Product Code	Product Name	Factory	Page	Durability	Active Soluble Salts	Compressive Strength N/mm <sup>2</sup> (z)	Water Absorption % (s)	Size Tolerance Mean & Range		Pock Quantity	Maximum Load Size <sup>▲</sup>	Brick Height mm	Dry Brick Weight Kg	Shrink-wrap	Palletised
								BS EN771-1	BS EN771-1						
<b>S</b>															
A0778A	Sussex Blend	West Hoathly	42	F2	S2	20	12	T2	R1	500	10,500	65	2.3	*	*
A4301A	Swanage Handmade Heather Red	Swanage	19	F2	S2	15	13	T1	R1	476	9,520	65	2.5	Yes	Yes
A4302A	Swanage Handmade Light Red	Swanage	19	F2	S2	15	13	T1	R1	476	9,520	65	2.5	Yes	Yes
B4302A	Swanage Handmade Light Red 50mm	Swanage	19	F2	S2	15	13	T1	R1	588	11,760	50	2.5	Yes	Yes
A4303A	Swanage Handmade Light Red Multi	Swanage	43	F2	S2	15	13	T1	R1	476	9,520	65	2.5	Yes	Yes
A4312A	Swanage Handmade Restoration Red	Swanage	19	F2	S2	15	13	T1	R1	476	9,520	65	2.5	Yes	Yes
B4312A	Swanage Handmade Restoration Red 50mm	Swanage	19	F2	S2	15	13	T1	R1	588	11,760	50	2.5	Yes	Yes
E4317A	Swanage Imperial Light Stock 68mm	Swanage	18	F2	S2	15	13	T1	R1	420	8,400	68	2.9	Yes	Yes
E4316A	Swanage Imperial Red Stock 68mm	Swanage	18	F2	S2	15	13	T1	R1	420	8,400	68	2.9	Yes	Yes
<b>T</b>															
A0709A	Thakeham Red Multi Stock	Laybrook	42	F2	S2	25	14	Tm	Rm	475	11,400	65	2.3	*	*
A2724A	Throckley Old English	Throckley	24	F2	S2	60	10	T2	R1	500	12,000	65	2.3	Yes	*
A2702A	Throckley Red Rustic	Throckley	15	F2	S2	60	10	T2	R1	500	12,000	65	2.3	Yes	*
A2730A	Throckley Smooth Red	Throckley	13	F2	S2	60	10	T2	R1	500	12,000	65	2.3	Yes	*
A4041A	Tonbridge Handmade Grey Brown	Ashdown	63	F2	S2	30	15	T1	R1	392	10,192	65	2.4	Yes	Yes
B4041A	Tonbridge Handmade Grey Brown 50mm	Ashdown	63	F2	S2	30	15	T1	R1	480	10,560	50	2	Yes	Yes
A4042A	Tonbridge Handmade Heather Grey	Ashdown	63	F2	S2	30	15	T1	R1	392	10,192	65	2.4	Yes	Yes
B4042A	Tonbridge Handmade Heather Grey 50mm	Ashdown	63	F2	S2	30	15	T1	R1	480	10,560	50	2	Yes	Yes
A4043A	Tonbridge Handmade Multi	Ashdown	43	F2	S2	30	15	T1	R1	392	10,192	65	2.4	Yes	Yes
B4043A	Tonbridge Handmade Multi 50mm	Ashdown	43	F2	S2	30	15	T1	R1	480	10,560	50	2	Yes	Yes
A4044A	Tonbridge Handmade Pastone	Ashdown	51	F2	S2	30	15	T1	R1	392	10,192	65	2.4	Yes	Yes
B4044A	Tonbridge Handmade Pastone 50mm	Ashdown	51	F2	S2	30	15	T1	R1	480	10,560	50	2	Yes	Yes
A2623A	Townhouse Blend	Birtley	35	F2	S2	20	12	Tm	Rm	392	10,976	65	2.7	Yes	*
A0314A	Tradesman Antique Grey	Atlas	61	F2	S2	60	9	T2	R1	400	11,200	65	2.4	*	*
A0389A	Tradesman Antique Rustic Blend	Atlas	32	F2	S2	60	9	T2	R1	400	11,200	65	2.3	*	*
C0389A	Tradesman Antique Rustic Blend 73mm	Atlas	32	F2	S2	60	9	T2	R1	336	9,408	73	2.8	*	*
A0304A	Tradesman Buff Multi	Atlas	54	F2	S2	60	9	T2	R1	400	11,200	65	2.3	*	*
A0385A	Tradesman Cheviot	Atlas	33	F2	S2	60	9	T2	R1	400	11,200	65	2.4	*	*
A0329A	Tradesman Claygate Red Multi	Atlas	33	F2	S2	60	9	T2	R1	400	11,200	65	2.4	*	*
A3598A	Tradesman Common	Ravenhead	22	F2	S2	50	12	T2	R1	500	12,500	65	2.4	+	+
A0381A	Tradesman Heather Mixture	Atlas	58	F2	S2	60	9	T2	R1	400	11,200	65	2.4	*	*
C0381A	Tradesman Heather Mixture 73mm	Atlas	58	F2	S2	60	9	T2	R1	336	9,408	73	2.8	*	*
A0382A	Tradesman Light	Atlas	61	F2	S2	60	9	T2	R1	400	11,200	65	2.4	*	*
C0382A	Tradesman Light 73mm	Atlas	61	F2	S2	60	9	T2	R1	336	9,408	73	2.8	*	*
A3542A	Tradesman Light Rustic Blend	Ravenhead	33	F2	S2	50	12	T2	R1	500	12,500	65	2.2	+	+
A0620A	Tradesman Millgate Buff	Cattybrook	54	F2	S2	50	12	T2	R1	500	11,000	65	2.3	*	*
A0383A	Tradesman Rustic Blend	Atlas	33	F2	S2	60	9	T2	R1	400	11,200	65	2.3	*	*
C0383A	Tradesman Rustic Blend 73mm	Atlas	33	F2	S2	60	9	T2	R1	336	9,408	73	2.8	*	*
A0384A	Tradesman Sandfaced Red Multi	Atlas	27	F2	S2	60	9	T2	R1	400	11,200	65	2.4	*	*
A0323A	Tradesman Tudor Regent	Atlas	33	F2	S2	60	9	T2	R1	400	11,200	65	2.3	*	*
A0395A	Tradesman Windsor Regent	Atlas	17	F2	S2	60	9	T2	R1	400	10,400	65	2.3	*	*
A3576A	Trafford Multi Rustic	Ravenhead	53	F2	S2	50	12	T2	R1	404	12,500	65	2.2	+	+
A2701A	Tyne Red Bark	Throckley	15	F2	S2	60	10	T2	R1	500	12,000	65	2.3	Yes	*
<b>W</b>															
A2613A	Warwickshire Olde English	Birtley	35	F2	S2	20	12	Tm	Rm	392	10,976	65	2.6	Yes	*
C2613A	Warwickshire Olde English 73mm	Birtley	35	F2	S2	20	12	Tm	Rm	328	9,184	73	3.2	Yes	*
A4046A	West Hoathly Handmade Multi Stock	Ashdown	43	F2	S2	30	15	T1	R1	392	10,192	65	2.4	Yes	Yes
B4046A	West Hoathly Handmade Multi Stock 50mm	Ashdown	43	F2	S2	30	15	T1	R1	480	10,560	50	2	Yes	Yes
A0731A	West Hoathly Medium Multi Stock	West Hoathly	40	F2	S2	20	12	T2	R1	500	11,000	65	2.3	*	*
A0736A	West Hoathly Sharpthorne Mixture Stock	West Hoathly	42	F2	S2	20	12	T2	R1	500	11,000	65	2.3	*	*
A0662A	Westbrick Red Purple Multi	Cattybrook	25	F2	S2	50	10	T2	R1	500	11,000	65	2.4	*	*
A3055A	Weston Red Multi Stock	Parkhouse	43	F2	S2	15	13	T2	R1	500	10,500	65	2.5	*	*
A5145A	White Engobe	Imports	45	F2	S2	40	6	T2	R2	520	+	65	1.6	Yes	Yes
A2407A	Windsor	Dorket Head	27	F2	S2	40	16	T2	R1	475	13,300	65	2.1	Yes	*
A3509A	Worsley Weathered	Ravenhead	33	F2	S2	50	12	T2	R1	404	+	65	2.2	+	+
A2800A	Wylam Olde Blend	Throckley	25	F2	S2	60	10	T2	R1	500	12,000	65	2.3	Yes	*





# Ibstock Brick

## Ibstock Brick

Leicester Road, Ibstock,  
Leicestershire LE67 6HS

t: 01530 261999 f: 01530 257457

e: [enquiries@ibstock.co.uk](mailto:enquiries@ibstock.co.uk)

[www.ibstockplc.co.uk](http://www.ibstockplc.co.uk)



## Contact Numbers

Technical & Design Advice Helpline:

**0844 800 4576**

Sample & Literature Hotline:

**0844 800 4578**

To be directed to the nearest sales office call:

**0844 800 4575 or ring:**

### 1. Scottish Sales Office

t: 0844 800 4871 f: 0844 800 4872

### 2. Parkhouse Sales Office

t: 0844 800 4867 f: 0844 800 4868

### 3. Lodge Lane Sales Office

t: 0844 800 4869 f: 0844 800 4870

### 4. Leicester Sales Office

t: 0844 800 4875 f: 0844 800 4876

### 5. Cattybrook Sales Office

t: 0844 800 4570 f: 0844 800 4571

### 6. Special Shapes Sales Office

t: 0844 736 0350 f: 0844 736 0351

## Ibstock Brick's Commitment To Quality

### IBSTOCK REGISTERED FIRMS

The first Quality Assurance Scheme in the industry, operating in accordance with BS EN ISO 9001 to be awarded Registered Firm Status for the design and the manufacture of bricks, pavers and special shapes.

## Ibstock Brick's Commitment to the Environment

In being the first UK brick manufacturer to achieve ISO 14001, the internationally recognised standard for all production sites and fully embracing the Government's strategy for sustainability, Ibstock Brick leads the way in demonstrating environmental responsibility. Ibstock Brick's commitment to responsible sourcing is demonstrated through their accreditation to BES 6001.

Although the instructions contained in this publication and any other information published by Ibstock are believed to be accurate at the date of publication, they are strictly for guidance only and [the Company] accepts no liability in relation to their use or for any losses, howsoever caused. You are responsible for taking all reasonable steps to ensure your use of the goods/products conforms to all applicable health and safety requirements from time to time. If in doubt, please consult appropriately qualified persons. All products sold by Ibstock Brick are sold subject to Ibstock Brick's Terms and Conditions of Sale, a copy of which is available on request.

The product photographs represent as accurately as possible, within the limitations of photography and printing, the colour of a representative sample of this range of products. However Ibstock does not warrant that all bricks produced in this range will match exactly the colours reproduced in this brochure.

View CE marking information at [www.ibstock-ce.com](http://www.ibstock-ce.com)

© Ibstock Brick 2019



**Ibstock**  
At the heart of building